

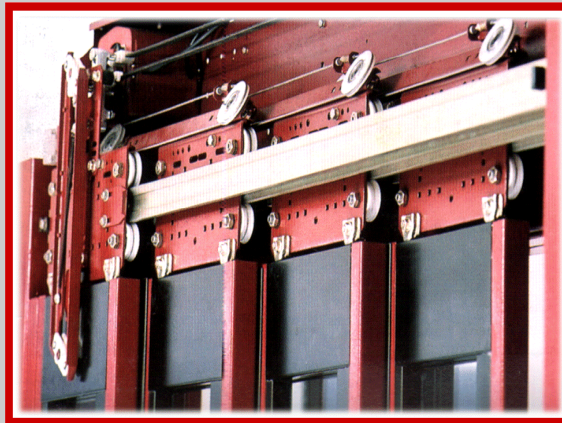

GLOBAL
Lift Equipment

Fermator Door Spares



FERMATOR DOOR SPARES 2011

Units H42/43 Ashmount Enterprise Park, Flint, Flintshire, CH6 5YL.
Tel: 01352 735400 Fax: 01352 735733 Email: sales@global-lift.com www.global-lift.com

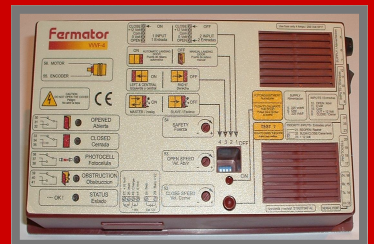

Fermator
AUTOMATIC DOORS FOR LIFTS



introduction

We are the Official UK Distributor for FERMATOR Door Equipment.

We stock a wide range of Fermator Spares Parts for immediate despatch

This catalogue illustrates a range of the most common Fermator Door Spares held in stock by Global.

For items not illustrated please contact our Sales Department on 01352 735400

We hope you find this booklet useful and welcome your feedback.

Just a few reminders.....

- All prices published already have your usual GLE Trade Discount deducted
- Our Minimum Order Charge is £40.00
- We offer free UK mainland next day by 5pm delivery for orders under 15kg
- Prices exclude VAT
- Our daily order cut off time for next day deliveries is 2.30pm
- Many items shown are available for collection from either our premises in **FLINT**, **Atlas Elevator Equipment** in **DUBLIN** or at the **PEW** Trade Counter in **LONDON**

Global Lift Equipment Ltd
 H42/43 Ashmount Enterprise Park
 Flint, Flintshire, CH6 5YL
 Tel: 01352 735400
 Fax: 01352 735733
 Email: sales@global-lift.com
 www.global-lift.com



Atlas Elevator Equipment
 Unit B15 Kingswood Business Park
 Dublin 22
 Tel: 00 353 1 4594106
 Fax: 00 353 1 4594025
 Email: aiden@sharkey.ie



PEW Electrical Distributors Ltd
 Unit 1 The IO Centre, 59-71 River Road
 Barking, Essex, IG11 ODR
 Tel: 0870 600 6503
 Fax: 0870 600 6603
 Email: sales@pewelectrical.com
 www.pewelectrical.com



Please refer to our website for our full range of products
www.global-lift.com

TOP TRACKS	40/10 & 50/11 General Details	Page 3
CAR General	Skates VVVF4 Control Box Motors - Sliding & Folding Rollers Belts - Sliding & Folding Bottom Tracks - Sliding	Page 4-6 Page 7 Page 8 Page 9 Page 10-11 Page 12
CAR VF Sliding	VF Automatic Spares VF Aircords	Page 13-18 Page 19
CAR AC Sliding	AC Mechanical Spares AC Aircords	Page 20-24 Page 25
CAR 4 Leaf Folding	Folding Spares - Zigzag Model Folding Spares - Flat Model Folding - Drive Arm Lengths	Page 26-29 Page 30-33 Page 34
CAR RAC 250 Operator	Special Order Spare Parts	Page 35-36
LANDING General Sliding	Top Tracks, Lock Beaks & Mechanisms Rollers Brackets Bottom Tracks	Page 37 Page 38 Page 39 Page 40
LANDING 40/10	40/10 Lock 40/10 Spares 40/10 Aircords	Page 41 Page 42-47 Page 48
LANDING 50/11	50/11 Lock 50/11 Spares 50/11 Aircords	Page 49 Page 50-51 Page 52
LANDING Hinged	Mechanical Cams Semi Automatic Hinged Spares Locks	Page 53 Page 54-56 Page 57-58
DOOR Tools	VVVF Programming Console Assembly Tool - Frameless Landings	Page 59 Page 59
ORDERING	Rapid Order Form	Page 60

Please Note: **CO** = Clear Opening.

Hand of Doors - as doors open as viewed from the landing.

50/11 VVVF CAR OPERATORS



2 Panel Centre Parting Operator

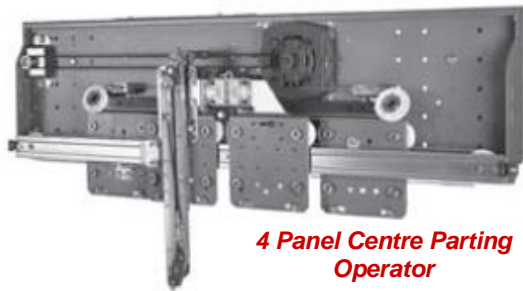

4 Panel Centre Parting Operator

40/10 LANDING MECHANISMS



2 Panel Centre Parting Mechanism

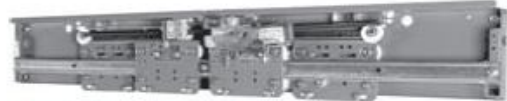

4 Panel Centre Parting Mechanism



2 Panel Side Opening Mechanism



3 Panel Side Opening Mechanism

40/10 & 50/11 TOP TRACKS



40/10

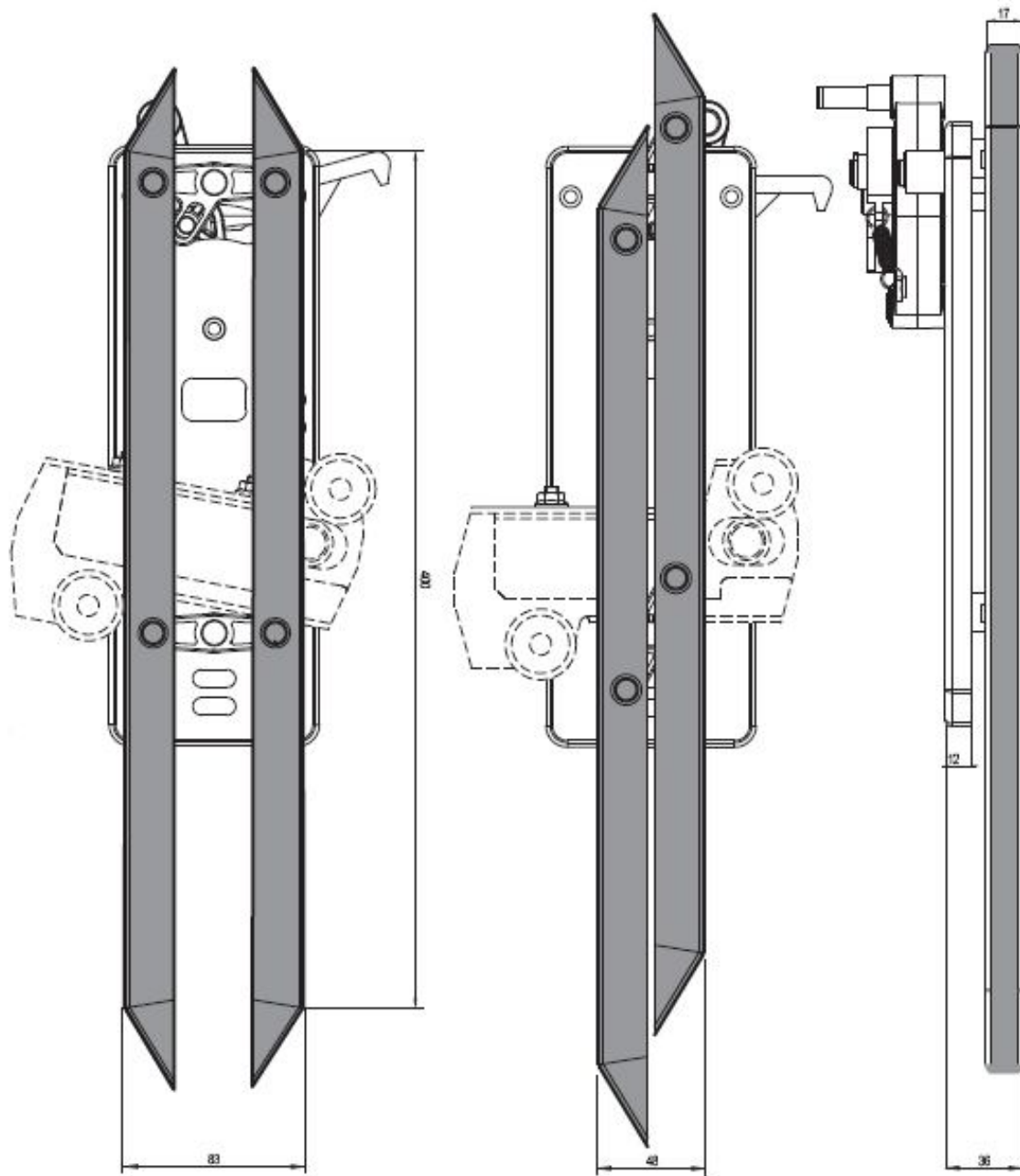

50/11

Standard VVVF Skate for use with Automatic Landings

Part number: 90.16.00 - please refer to page 5

Left Hand Opening Skate is shown

*Hand of Doors - as doors open as viewed from the landing.
Your Trade Discount has already been deducted. Prices exclude VAT.*

Car: SKaTES



AC MECHANICAL SKATE

2 Panel Opening - Universal

Part numbers:

- 40.10.00/LH Left Hand**
- 40.10.00/CP Centre Parting**
- 40.10.00/RH Right Hand**



INVERTED VF SKATE

2 Panel Opening - Left hand shown

Part numbers:

- 40.20.00/LH Left Hand**
- 40.20.00/CP Centre Parting**
- 40.20.00/RH Right Hand**



STANDARD VF SKATE

2 Panel Opening - Left hand shown

Part numbers:

- 90.16.00/2LH Left Hand**
- 90.16.00/2CP Centre Parting**
- 90.16.00/2RH Right Hand**



100MM EXTENDED VF SKATE

2 Panel Opening - Right hand shown

Part numbers:

- 90.16.00/EXT2LH/CP Left Hand & Centre parting**
- 90.16.00/EXT2RH Right Hand**

Other skates available, please contact office for details.

*Hand of Doors - as doors open as viewed from the landing.
Your Trade Discount has already been deducted. Prices exclude VAT.*

Car: SKaTES

Car Door Locking Skates* are available for retrofit to VF Car Operators originally supplied by Global Lift Equipment. Please contact Sales for further details.

Car Door Locking Skates to suit Centre Parting Doors

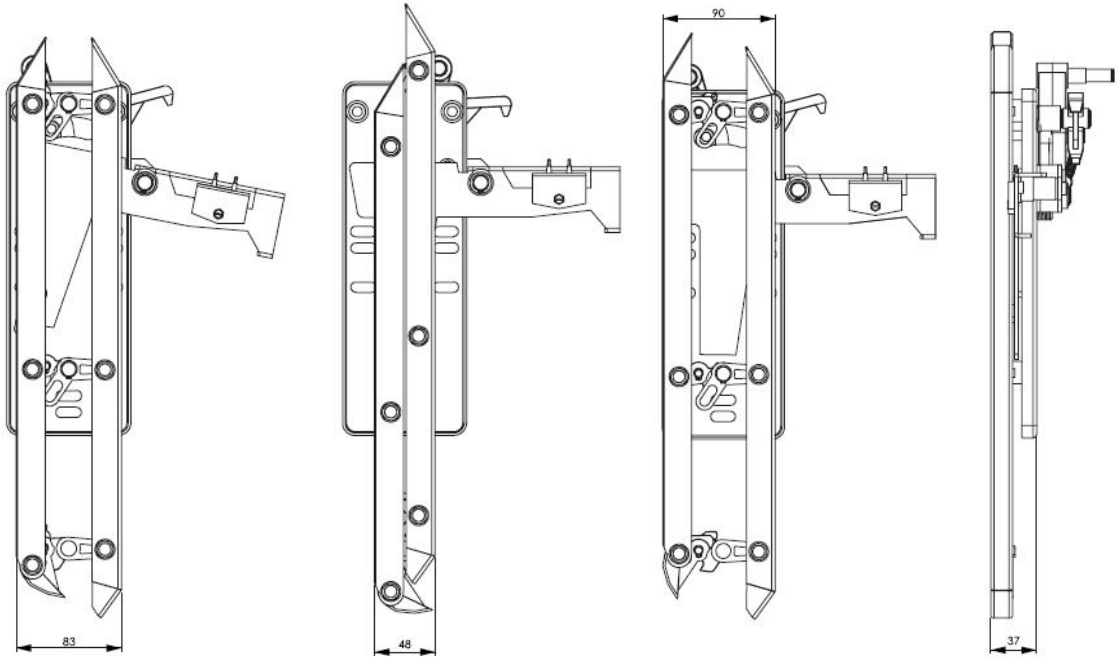

Special Order with operator - NB: WE CAN NOT SUPPLY AS SPARES

Car Door Locking Skates to suit Side Opening Doors

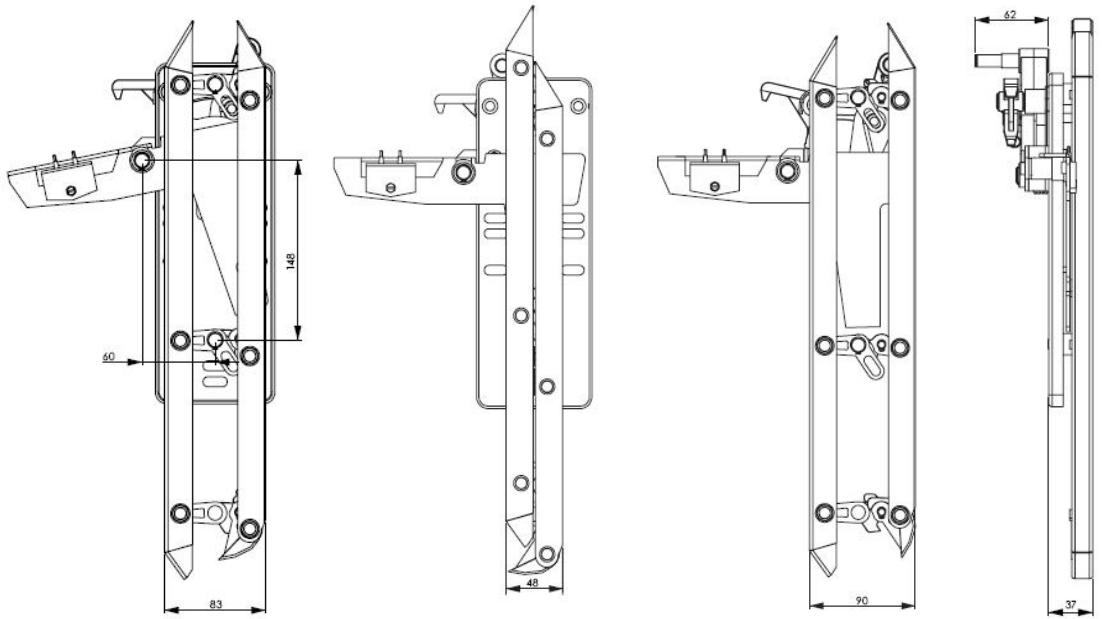

Special Order with operator - NB: WE CAN NOT SUPPLY AS SPARES

Right Hand Opening Skate is shown (as doors open as viewed from the landing).

Your Trade Discount has already been deducted. Prices exclude VAT.

RETROFIT VVVF4+ FROM VVVF3

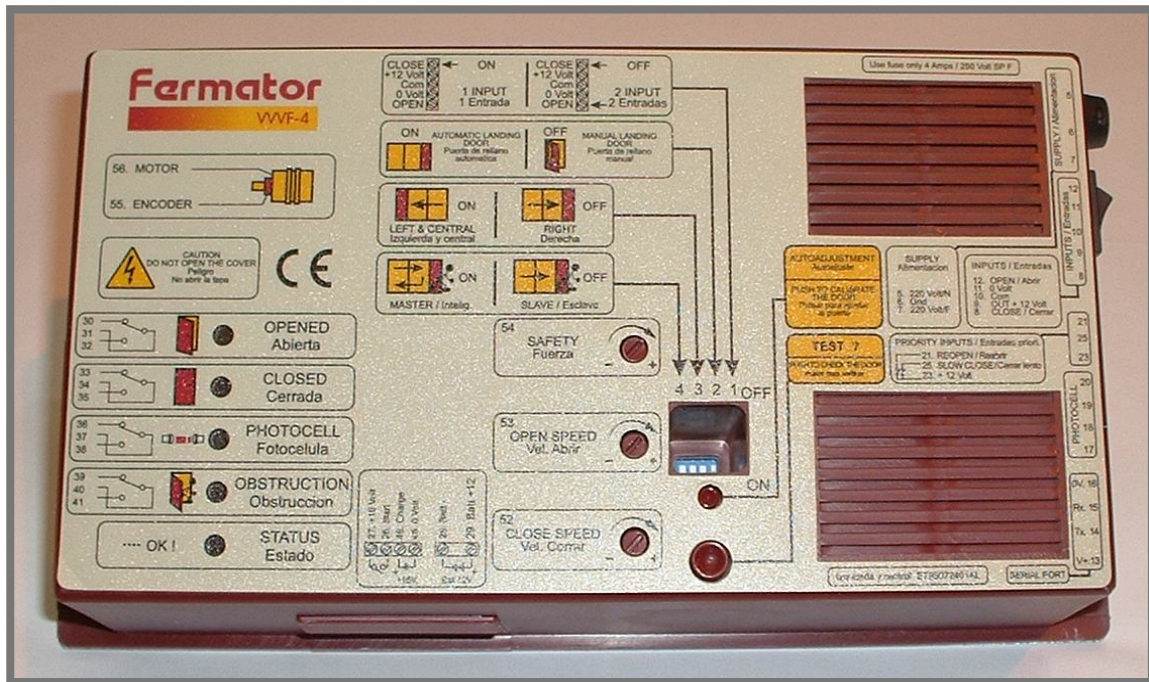

FERMATOR VVVF4+ CONTROL BOX

PART No: 90.30.10/V4

Replacement VVVF drive unit for use on Fermator VVVF Car Operators.

Backward compatible with all Fermator VVVF modules

To retro fit VVVF4 Unit in place of a VVVF3 Unit -

Drill 2 new mounting holes - 6mm diameter

Then the difference between the two units in terms of wiring are in the VVVF4+ Unit.

The following inputs are not present on the VVVF4+:

- No Fast Close Signal (Terminal 24 on VVVF3)
- No 'ok' output (Terminals 42,43,44)

Also on the VVVF4+ Unit the mains filter is internally built in.

*Hand of Doors - as doors open as viewed from the landing.
Your Trade Discount has already been deducted. Prices exclude VAT.*

VVVF OPERATORS

STANDARD 50/11 Motor - VVVF
Includes Casing, Pulley, Encoder & Wires
Tipo 125/40

230 v, 900 rpm, 50 hz, 1.1 amp

Part number: 90.11.15

PM/LB OPERATORS

STANDARD Permanent Magnet Motor
Includes Casing, Pulley, Encoder & Wires

Brushless Tipo 120/10

Part number: 90.11.15/PM300

AC OPERATORS

AC Mechanical Operator Motor - 2 phase
Includes Motor only

Tipo 125/30

230 v, 300 rpm, 50 hz, 1.1 amp

Part number: 10.21.01

AC Mechanical Operator Motor - 3 phase
Includes Motor only

Tipo 125/40

125/216 v, 430 rpm, 50 hz, 0.99/0.57 amp

Part number: 10.21.06

FOLDING OPERATORS











Folding Door Motor - 2 phase
Includes Motor only

Tipo 90/45







230 v, 645 rpm, 50 hz, 0.58 amp

Part number: 50.10.01

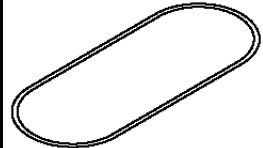
Other motors available, please contact office for details.

TYPE	PART NO	DETAILS		IMAGE
CAR VVVF	90.26.00	Hanger Roller Concentric 56mm		
CAR VVVF	90.27.00	Kicking Roller Eccentric 54mm		
CAR Mechanical	10.70.20	Hanger Roller Concentric 48mm		
CAR Mechanical	10.70.10	Kicking Roller Eccentric 48mm		
CAR Mechanical	10.70.22	Kicking Roller Eccentric 48mm (3 panel side)		
LANDING 40/10	10.70.20	Hanger Roller Concentric 48mm		
LANDING 40/10	10.70.23	Kicking Roller Eccentric 30mm		
LANDING 50/11	90.26.00	Hanger Roller Concentric 56mm		
LANDING 50/11	90.27.00	Kicking Roller Eccentric 54mm		
LANDING 40/10	20.81.02	2 Lock Rollers Mounted on Lock Plate <i>Hand of Doors</i>		
LANDING 50/11	20.81.02	2 Lock Rollers Mounted on Lock Plate <i>Hand of Doors</i>		

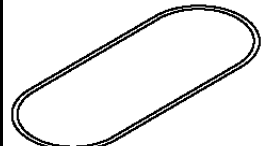
*Hand of Doors - as doors open as viewed from the landing.
Your Trade Discount has already been deducted. Prices exclude VAT.*

MODEL	SIZE	TYPE		IMAGE
VVVF 90.15.00	See Page 11	Black Cogged HTD-5M		
Mechanical 10.20.03	W= 7mm L= 870mm	White Round Elastic		
Mechanical 10.21.03	W= 8mm L= 930mm	Black Smooth		
Mechanical 10.30.03	W= 18mm L= 1100mm	Black Toothed 450 L 075		
Folding 50.10.14	W= 6mm L= 850mm	Black Toothed For DC Motor		
Folding 50.20.01	W= 5mm L= 650mm	White or Orange Round Elastic V Belt		
Folding 50.20.03	W= 10mm L= 450mm	Black Toothed 3 on one car 450 HTD 5M		
Folding 50.20.11	W= 6mm L= 735mm	Black Trapecial Smooth V groove		

*Hand of Doors - as doors open as viewed from the landing.
Your Trade Discount has already been deducted. Prices exclude VAT.*

90.15.00 VF DRIVE BELT

Clear Opening (mm)	2 PCP (mm)	4 PCP (mm)	6 PCP (mm)	8 PCP (mm)	Single (mm)	2 PSO (mm)	3 PSO (mm)	4 PSO (mm)
500						1470		
550	1550				1550	1570		
600	1650	1116			1650	1670	1670	1510
650	1700	1190			1750	1770	1770	1630
700	1750	1266			1850	1870	1870	1760
750	1800	1340			1950	1970	1970	1882
770	1820	1370			1990	2010	2010	1934
800	1850	1416			2050	2070	2070	2010
850	1900	1490			2150	2170	2170	2134
900	1950	1566			2250	2270	2270	2260
915	1965	1590			2280	2300	2300	2300
950	2000	1640			2350	2370	2370	2282
1000	2050	1716	2590		2450	2470	2470	2410
1050	2100	1790	2650		2550	2570	2570	2534
1100	2150	1866	2850		2650	2670	2670	2660
1150	2200	1940	2950		2750	2770	2770	2782
1200	2250	3406	3050		2850	2870	2870	2910
1250	2300	3556	3250		2950	2970	2970	3030
1300	2350	3706	3350		3050	3070	3070	3160
1350	2400	3856	3450		3150	3170	3170	3282
1400	2450	3860	3650	2590	3250	3270	3270	3350
1450	2500	4010	3750	2650	3350	3370	3370	3450
1500	2550	4160	3850	2850	3450	3470	3470	3550
1600	2650	4460	4150	2950	3650	3670	3670	3750
1700	2750	4560	4450	3050		3870	3870	3950
1800	2850	4860	4650	3250		4070	4070	4150
1900	2950	4960	4950	3350		4270	4270	4350
2000	3050	5260	5050	3450		4470	4470	4550
2100		5360	5250	3650		4670	4670	4750
2200		5660	5550	3750		4870	4870	4950
2300		5760	5650	3850		5070	5070	5150
2400		6060	5850	4150		5270	5270	5350
2500		6160	6150	4450		5470	5470	5550
2600		6460	6250	4650				
2700		6560	6450	4950				
2800		6860	6750	5050				
2900		6960	6850	5250				
3000		7260	7050	5550				

CAR: Bottom tRACKs



Standard Aluminium & Gold Anodised

Total Weight:
1200 kg

Load on Support Point:
300 kg

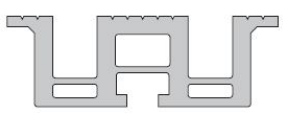

Reinforced Aluminium

Total Weight:
4800 kg

Load on Support Point:
1200 kg



Steel Section

Total Weight:
3600 kg

Load on Support Point:
900 kg

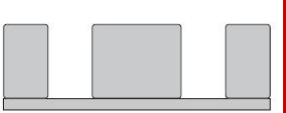

Solid Steel

Total Weight:
> 4800 kg

Load on Support Point:
> 1200 kg

The loads stated above are the maximum loads the tracks can support.







Prices are same for all configurations of tracks (i.e. single panel, 2 panel etc) **Contact Sales for other sizes.**

Type	Car	Landing	Slimline Car With Auto Landing	Slimline Car With Hinged Landing
Single Panel	54mm	54mm	n/a	n/a
2 Panel Centre	54mm	54mm	n/a	n/a
2 Panel Side	90mm	90mm	70mm	70mm
3 Panel Side	135mm	135mm	90mm	90mm & 70mm
4 Panel Centre	90mm	90mm	70mm	70mm & 80mm (700mm Clear opening only)
4 Panel Side	180mm	180mm	n/a	n/a
6 Panel Centre	135mm	135mm	90mm	n/a
8 Panel Centre	180mm	180mm	n/a	n/a

Clear Opening	Standard Aluminium	Reinforced Aluminium	Gold Anodised	Steel Section	Solid Steel	Stainless Steel Section	Solid Stainless Steel
500 mm							
600 mm							
700 mm							
800 mm							
900 mm							
1000 mm							
1100 mm							
1200 mm							
1300 mm							
1400 mm							
1500 mm							
1600 mm							
1700 mm							
1800 mm							
1900 mm							
2000 mm							
2100 mm							
2200 mm							

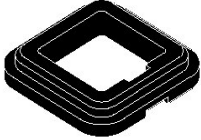
Your Trade Discount has already been deducted. Prices exclude VAT.

Car: vvvf







PART NO	ITEM		IMAGE
90.10.00	PAIR OF OPERATOR SUPPORTS		
90.11.02/D	MOTOR SUPPORT METAL 2 PIECE (current model shown) <i>Please refer to office for other models</i>		
90.11.03	RUBBER MOTOR MOUNTING (old model shown) <i>Please refer to office for other models</i>		
90.11.04	VVVF MOTOR PULLEY (fits on motor)		
90.11.06	ENCODER FOR MOTOR <i>NB- new encoder board mounts with electronic components protected and facing the motor</i>		
90.11.07	ENCODER WIRES		
90.11.15/ PM300	STANDARD PERMANENT MAGNET MOTOR Brushless Tipo 120/10		

*Hand of Doors - as doors open as viewed from the landing.
 Your Trade Discount has already been deducted. Prices exclude VAT.*

Car: vvvf

PART NO	ITEM		IMAGE
90.11.15	VVVF MOTOR COMPLETE WITH ENCODER, WIRES, CASE & MOTOR PULLEY See page 8 <i>NB— when replacing old type motor (with no cover), remove the plastic casing and reuse or replace rubber mounting</i>		
90.12.00	IDLER RETURN PULLEY NYLON		
90.13.00	MOUNTING BRACKET WITH IDLER RETURN PULLEY (Current model shown) <i>Please specify type & sill width</i>		
90.14.00	PLASTIC CONNECTOR FOR VF HTD BELT		
90.15.00	VVVF TOOTHED BELT HTD-5M BELT (indicate CO) <i>Indicate type & clear opening</i> <i>Please refer to table on page 10 for lengths</i>		
90.16.00	SKATE SET <i>Indicate type/hand & CO</i> <i>See Pages 4 & 5</i>		



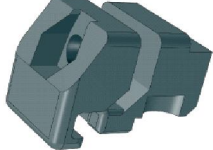



*Hand of Doors - as doors open as viewed from the landing.
 Your Trade Discount has already been deducted. Prices exclude VAT.*

PART NO	ITEM		IMAGE
90.16.02	SKATE TRIGGER <i>(Moving part)</i>		
90.16.04	SKATE TRIGGER SPRING		
90.16.05	CONNECTING ROD RUBBER STOPPER		
90.16.08	DRAGGING PLATE SET FOR SEMI AUTO DOOR <i>Indicate type/hand</i>		
90.17.00	SKATE TRIGGER (FIXED) STOPPING RETAINER ASSEMBLY <i>(2 panel Centre Parting Shown)</i> <i>Indicate type/hand</i>		
90.17.02	SKATE TRIGGER (Fixed)		
90.17.04	SPRING FOR SKATE TRIGGER (Fixed)		
90.18.00	AIR CORD CLAMP <i>Fixing bolt not included</i>		

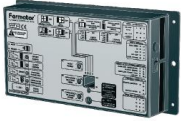
*Hand of Doors - as doors open as viewed from the landing.
Your Trade Discount has already been deducted. Prices exclude VAT.*

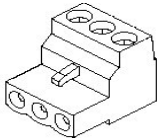
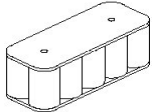
PART NO	ITEM		IMAGE
90.19.00	SET OF 2 BOTTOM GUIDE SHOES		
90.22.00	CAR DOOR CONTACT (2 pieces) <i>These parts are the same as part numbers: 50.50.25 - folding doors 10.50.25 - mechanical operators</i>		
90.23.00	AIR CORD - CAR <i>Please refer to air cord table on page 19 for sizes</i>		
90.24.00	AIR CORD WHEEL 64mm Ø		
90.26.00	CONCENTRIC HANGER ROLLER 56mm Ø <i>Also used on 50/11 landings</i>		
90.27.00	ECCENTRIC KICKING ROLLER 54mm Ø <i>Also used on 50/11 landings</i>		

*Hand of Doors - as doors open as viewed from the landing.
Your Trade Discount has already been deducted. Prices exclude VAT.*

PART NO	ITEM		IMAGE
90.30.10/V4	VVVF4+ CONTROL BOX <i>For further details refer to Page 7</i>		
90.30.10/V5	VVVF5 CONTROL BOX		
90.30.11	BATTERY BACK UP CIRCUIT BOARD		
90.30.12	CONNECTORS FOR VVVF4 UNIT <i>Indicate number of connections</i>		
90.30.13	BATTERY 12vdc 1.2mah		
90.32.00	COMPLETE PHOTOCELL (Emitting & Receiving)		
90.33.00	RUBBER STOP (20 x 30mm)		
90.33.01	RUBBER STOP (25 x 30mm)		
90.34.00	VVVF4 PROGRAMMING CONSOLE If purchased with VF Car Operator, special price:		

*Hand of Doors - as doors open as viewed from the landing.
Your Trade Discount has already been deducted. Prices exclude VAT.*

PART NO	ITEM		IMAGE
90.35.00	RUBBER STOP FOR CLEAR OPENING BRACKET <i>'L' Bracket Not included</i>		

*Hand of Doors - as doors open as viewed from the landing.
Your Trade Discount has already been deducted. Prices exclude VAT.*

*AIRCORD LENGTHS - All sizes are in mm.**Prices available on request.**PCP = CENTRE PARTING DOORS**PSO = SIDE OPENING DOORS**PART CODE: 90.23.00/length required*

Clear Opening	2PCP	4PCP (1)	4PCP (2)	6PCP	8PCP	2PSO	3PSO	4PSO
600	2380	1920	680	-	-	1080	860	-
650	2480	2020	730	-	-	1180	860	760
700	2580	2180	760	-	-	1180	960	760
750	2680	2320	810	-	-	1280	960	810
800	2780	2480	810	-	-	1280	1010	860
850	2880	2620	860	-	-	1380	1010	860
900	2980	2780	910	-	-	1380	1080	910
950	3080	2910	960	-	-	1480	1080	910
1000	3180	3080	1010	-	-	1480	1180	960
1100	3380	3380	1080	-	-	1580	1280	1010
1200	3580	-	1080	810	-	1680	1280	1060
1300	3780	-	1180	860	-	1780	1380	1110
1400	3980	-	1180	960	760	1880	1480	1180
1500	4180	-	1280	1010	810	1980	1480	1280
1600	4380	-	1280	1010	810	2080	1580	1280
1700	-	-	1380	1080	860	2180	1680	1380
1800	-	-	1380	1080	910	2280	1680	1380
1900	-	-	1480	1140	960	2380	1780	1480
2000	-	-	1480	1180	960	2480	1880	1480
2100	-	-	1580	1180	1010	-	-	-
2200	-	-	1580	1280	1010	-	-	-
2300	-	-	1680	1280	1060	-	-	-
2400	-	-	1680	1280	1080	-	-	-
2500	-	-	1780	1380	1080	-	-	-
2600	-	-	1780	1380	1110	-	-	-
2700	-	-	1880	1480	1140	-	-	-
2800	-	-	1880	1480	1180	-	-	-
2900	-	-	1980	1480	1180	-	-	-
3000	-	-	1980	1580	1280	-	-	-

*(1): Aircord Length Across Entrance**(2): Aircord Length Across Door Panel*







*Hand of Doors - as doors open as viewed from the landing.
Your Trade Discount has already been deducted. Prices exclude VAT.*

Car: aC MECHaNICaL

PART NO	ITEM		IMAGE
10.10.10	PAIR OF OPERATOR SUPPORTS		
10.20.03	WHITE ROUND ELASTIC BELT 7mm wide 870mm long		
10.21.01	2 PHASE MOTOR 230V <i>See Page 8</i>		
10.21.02	MOTOR PULLEY 30, 48 or 58mm Ø		
10.21.03	BLACK SMOOTH BELT 8mm wide 930mm long V Belt <i>Other sizes available</i>		
10.21.06	3 PHASE MOTOR 125/216 V <i>See Page 8</i>		
10.30.01	INTERMEDIATE PULLEY WITH SHAFT		

*Hand of Doors - as doors open as viewed from the landing.
Your Trade Discount has already been deducted. Prices exclude VAT.*

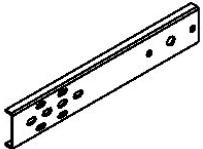
Car: aC MECHaNICaL





PART NO	ITEM		IMAGE
10.30.03	TOOTHED BELT (450 L 075) 18mm Wide x 1100mm Long <i>450mm x 75mm available special order</i>		
10.40.10	MICROSWITCH OPERATOR PULLEY CAM		
10.41.01	WORKING CENTRAL PULLEY IN ALUMINIUM WITH SHAFT		
10.50.01	CLEAR OPENING REGULATION		
10.50.02	PANEL RUBBER STOP		
10.50.11	OPERATOR METAL ARM <i>Indicate type/hand & clear opening</i>		
10.50.12	RUBBER STOP WITH M8 BOLT		
10.50.13	TOP TRACK 40/10 <i>Indicate type/hand & clear opening</i>		

*Hand of Doors - as doors open as viewed from the landing.
 Your Trade Discount has already been deducted. Prices exclude VAT.*

Car: aC MECHaNICaL

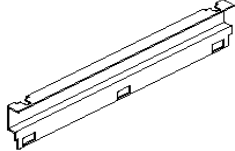
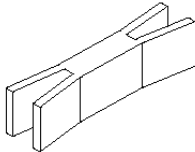



PART NO	ITEM		IMAGE
10.50.16	ELECTRICAL CONNECTOR		
10.50.18	CAPACITOR 8 UF 450V		
10.50.24	SAFETY WIRE Ref: HO5RN-F		
10.50.25 - Please quote code 90.22.00	CAR DOOR CONTACT (2 pieces) <i>These parts are the same as part numbers: 50.50.25 - folding doors 90.22.00 - VVVF operators</i>		
10.70.06	AIR CORD - CAR <i>Please refer to air cord table on page 25 for sizes</i>		
10.70.07	AIR CORD WHEEL <i>Advise diameter: 42, 47, 50, 60mm Indicate Ø of internal hole - 6mm or 8mm)</i>		

*Hand of Doors - as doors open as viewed from the landing.
Your Trade Discount has already been deducted. Prices exclude VAT.*

PART NO	ITEM		IMAGE
10.70.10	KICKING ROLLER WITH ECCENTRIC SHAFT 48mm Ø		
10.70.12	DOWN VULKALLAN GUIDE (indicate type/hand & CO) Special order <i>Please advise if 165 or 365 mm</i>		
10.70.13	DOWN SKATE VULKALLAN (Door Spud) Special order		
10.70.20	HANGER ROLLER WITH CONCENTRIC SHAFT 48mm Ø		
10.70.22	KICKING ROLLER WITH ECCENTRIC SHAFT 48mm Ø <i>Suits 3PSO 90mm sill</i>		
10.80.05	TOE GUARDS - CAR <i>Indicate clear opening</i>		
10.90.01	FIXED CAM FOR SEMI AUTO DOORS <i>Indicate hand</i>		
30.10.04	FINAL OPEN/CLOSE LIMIT SWITCH		
30.20.00	COMPLETE DRIVE ARM <i>Indicate type/hand & clear opening</i>		

*Hand of Doors - as doors open as viewed from the landing.
Your Trade Discount has already been deducted. Prices exclude VAT.*

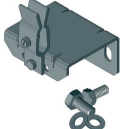
Car: aC MECHaNICaL

PART NO	ITEM		IMAGE
40.10.00	OLD AC MECHANICAL SKATE <i>Hand is Universal</i>		
40.10.07	DRIVE SPRING FOR SKATE <i>Indicate type & hand</i>		
40.10.09	DRIVER CAM FOR SKATE <i>Indicate type & hand</i>		
40.10.10	DRIVE ARM RETENTION <i>Indicate type & hand</i>		
40.10.11	RETENTION ROD <i>Indicate type & hand</i>		
40.20.00	INVERTED SKATE SET <i>See page 5</i> <i>Indicate type & hand</i>		

*Hand of Doors - as doors open as viewed from the landing.
 Your Trade Discount has already been deducted. Prices exclude VAT.*







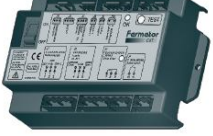
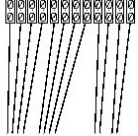

*AIRCORD LENGTHS - All sizes are in mm.**Prices available on request.***PCP = CENTRE PARTING DOORS****PSO = SIDE OPENING DOORS****PART CODE: 10.70.06/Length Required**

Clear Opening	2PCP	4PCP (1)	4PCP (2)	6PCP	8PCP	2PSO	3PSO	4PSO
600	2280	1880	630	-	-	1080	860	680
650	2280	2040	710	-	-	1080	960	710
700	2280	2180	710	-	-	1180	960	760
750	2430	2280	710	-	-	1180	1010	760
800	2580	2480	760	-	-	1280	1010	860
850	2730	2630	810	-	-	1280	1080	860
900	2880	2780	810	-	-	1380	1080	910
950	3030	2930	860	-	-	1380	1140	910
1000	3180	3080	860	-	-	1480	1140	960
1100	3480	3380	910	-	-	1580	1180	1080
1200	3780	-	1080	860	-	1680	1290	1080
1300	4080	-	1180	860	-	1780	1380	1180
1400	4380	-	1180	960	760	1880	1380	1180
1500	4680	-	1280	1010	760	1980	1480	1280
1600	4980	-	1280	1010	860	2080	1580	1280
1700	-	-	1380	1080	860	2180	1580	1380
1800	-	-	1380	1080	910	2280	1680	1380
1900	-	-	1480	1140	910	2380	1780	1480
2000	-	-	1480	1140	960	2480	1780	1480
2100	-	-	1580	1180	960	-	-	-
2200	-	-	1580	1180	1080	-	-	-
2300	-	-	1680	1290	1080	-	-	-
2400	-	-	1680	1290	1080	-	-	-
2500	-	-	1780	1380	1080	-	-	-
2600	-	-	1780	1380	1180	-	-	-
2700	-	-	1880	1380	1180	-	-	-
2800	-	-	1880	1380	1180	-	-	-
2900	-	-	1980	1480	1180	-	-	-
3000	-	-	1980	1480	1280	-	-	-

(1): Aircord Length Across Entrance**(2): Aircord Length Across Door Panel**

*Hand of Doors - as doors open as viewed from the landing.
Your Trade Discount has already been deducted. Prices exclude VAT.*

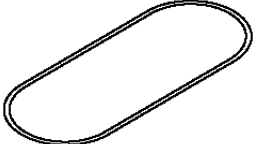
Car: ZIGZaG foLdInG

PART NO	ITEM		IMAGE
70.10.01	C2-T & C4-T PRINTED CIRCUIT BOARD		
70.10.02	C2-T CONNECTION WIRES With Molex Connectors		
20.20.04	LOCK SERIES SWITCH		
50.10.01	2 PHASE MOTOR 230V <i>See Page 8</i>		
50.10.02	RUBBER MOTOR MOUNTING		
50.10.03	MOTOR PULLEY 20mm Ø		
50.10.13	PLASTIC MOTOR PULLEY <i>Advise diameter: 35 or 43mm</i>		
50.10.14	TOOTHED PULLEY BELT FOR DC MOTOR 6mm Wide 850mm Long		
50.20.01	ELASTIC ROUND V BELT 650mm length 5mm wide <i>One size for all operators Older belts can be orange or white</i>		
50.20.02	REDUCTION PULLEY WITH FIXING		

*Hand of Doors - as doors open as viewed from the landing.
Your Trade Discount has already been deducted. Prices exclude VAT.*

PART NO	ITEM		IMAGE
50.20.03	BLACK TOOTHED BELT 450 HTD 5M 10mm Wide x 450mm long <i>There are 3 on one operator</i>		
50.20.04	TOOTHED REDUCTION PULLEY WHEEL <i>(No Key Slot)</i>		
50.20.05	TOOTHED REDUCTION PULLEY WHEEL <i>(With Key Slot)</i>		
50.20.06	CENTRAL SHAFT		
50.20.07	LATERAL SHAFT		
50.20.08	BELT GUIDE		
50.20.09	NYLON CENTRE BUSH INSERT		
50.20.11	DRIVE PULLEY BELT Trapezial (not cogged) V Groove Black 6mm wide x 735mm long		
50.20.12	REDUCTION PULLEY WHEEL <i>Trapezial groove - not toothed</i>		
50.30.01	DRIVE ARM SHAFT <i>Please advise hand</i>		

*Hand of Doors - as doors open as viewed from the landing.
Your Trade Discount has already been deducted. Prices exclude VAT.*

PART NO	ITEM		IMAGE
50.30.02	LATERAL BUSHING		
50.30.10	LIMIT SWITCH CAM		
50.40.01	CAPACITOR 6uf 450v		
50.40.03	SAFETY EDGE SWITCH WIRE <i>Advise length</i>		
50.50.00	COMPLETE DRIVE ARM ASSEMBLY <i>Advise length - refer to table on page 34 for sizes.</i>		
50.50.02	FINAL OPEN/CLOSE LIMIT SWITCH		
50.50.25 Please quote code 90.22.00	DOOR CONTACT ASSEMBLY (2 pieces) <i>These parts are the same as part numbers: 10.50.25 - Mechanical operator 90.22.00 - VVVF operators (Current model illustrated)</i>		
50.60.04	HINGE (ALCRIN) 2 metres <i>Rubber joining strip between door panels (1 only)</i>		

*Hand of Doors - as doors open as viewed from the landing.
Your Trade Discount has already been deducted. Prices exclude VAT.*

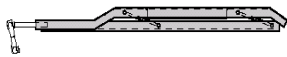
PART NO	ITEM		IMAGE
50.60.05	2 PIECE NYLON HINGE (set of 2)		
50.60.11	SET OF 4 DOOR GUIDE SHOES <i>4 shoes per entrance</i>		
50.60.12	CENTRE BUFFER STOP		
50.70.01	ALUMINIUM BOTTOM TRACK <i>Indicate clear opening</i>		
50.70.02	RAISED BOTTOM TRACK <i>Indicate clear opening</i> *Not available for flat model		
50.70.03	BOTTOM TRACK SUPPORT <i>Indicate clear opening</i>		
50.80.00	SIDE ACTING RETRACTING RAMP Not Handed—Universal <i>Refer to page 53</i>		
50.80.01	FRONT ACTING RETRACTING RAMP <i>Indicate hand</i> <i>Refer to page 53</i>		

*Hand of Doors - as doors open as viewed from the landing.
Your Trade Discount has already been deducted. Prices exclude VAT.*

PART NO	ITEM		IMAGE
70.10.01	C2-T & C4-T PRINTED CIRCUIT BOARD		
70.10.02	C2-T CONNECTION WIRES With Molex Connectors		
20.20.04	LOCK SERIES SWITCH		
50.10.01	2 PHASE MOTOR 230V <i>See Page 8</i>		
50.10.14	TOOTHED PULLEY BELT FOR DC MOTOR 6mm Wide 850mm Long		
50.16.03	SET OF 2 HANDLES FOR FLAT FOLDING DOOR		
50.20.03	BLACK TOOTHED BELT 450 HTD 5M 10mm Wide x 450mm long <i>There are 3 on one operator</i>		
50.20.04	TOOTHED REDUCTION PULLEY WHEEL <i>No Key Slot</i>		
50.20.05	TOOTHED REDUCTION PULLEY WHEEL <i>With Key Slot</i>		
50.20.06	CENTRAL SHAFT		

*Hand of Doors - as doors open as viewed from the landing.
Your Trade Discount has already been deducted. Prices exclude VAT.*



PART NO	ITEM		IMAGE
50.20.07	LATERAL SHAFT		
50.20.08	BELT GUIDE		
50.20.09	NYLON CENTRE BUSH INSERT		
50.20.12	REDUCTION PULLEY WHEEL <i>Trapezoidal groove - not toothed</i>		
50.30.01	DRIVE ARM SHAFT <i>Please advise hand</i>		
50.30.02	LATERAL BUSHING		
50.30.10	LIMIT SWITCH CAM		
50.40.01	CAPACITOR 6uf 450v		
50.40.03	SAFETY EDGE SWITCH WIRE <i>Advise length</i>		

*Hand of Doors - as doors open as viewed from the landing.
Your Trade Discount has already been deducted. Prices exclude VAT.*

Car: FLaT FoLding

PART NO	ITEM		IMAGE
50.50.00	COMPLETE DRIVE ARM ASSEMBLY <i>Advise length - refer to table on page 34 for sizes.</i>		
50.50.02	FINAL OPEN/CLOSE LIMIT SWITCH		
50.50.25 Please quote code 90.22.00	DOOR CONTACT ASSEMBLY (2 pieces) <i>These parts are the same as part numbers: 10.50.25 - Mechanical operator 90.22.00 - VVVF operators (Current model illustrated)</i>		
50.60.11	SET OF 4 DOOR GUIDE SHOES <i>4 shoes per entrance</i>		
50.60.12	CENTRE BUFFER STOP		
50.80.00	SIDE ACTING RETRACTING RAMP Not Handed—Universal <i>Refer to page 53</i>		
50.80.01	FRONT ACTING RETRACTING RAMP <i>Indicate hand Refer to page 53</i>		
50.90.04	SECONDARY DRIVE ARM <i>Indicate position</i>		

*Hand of Doors - as doors open as viewed from the landing.
Your Trade Discount has already been deducted. Prices exclude VAT.*

PART NO	ITEM		IMAGE
50.90.05	2 PIECE NYLON HINGE (set of 2)		
50.90.06	ALUMINIUM BOTTOM TRACK <i>Indicate clear opening</i>		
50.90.08	SILL SUPPORT FOR FLAT MODEL DOORS <i>Indicate clear opening</i>		

*Hand of Doors - as doors open as viewed from the landing.
Your Trade Discount has already been deducted. Prices exclude VAT.*

Car: folding drive arMS

Drive arm to suit Zigzag Model & Flat Model 4 Leaf Folding Car Door

PART CODE: 50.50.00/Length Required

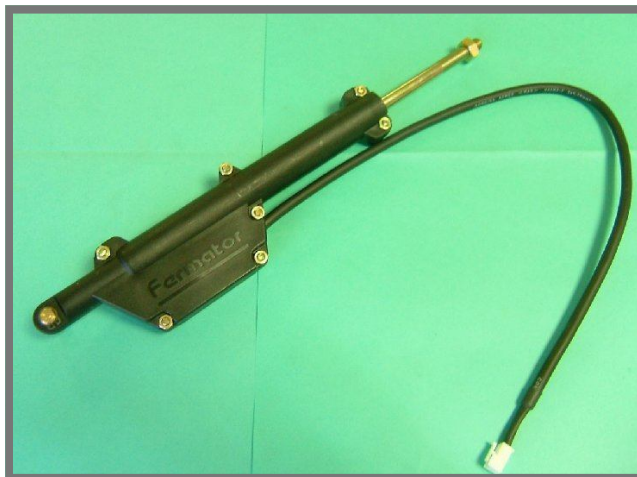

Length (mm)

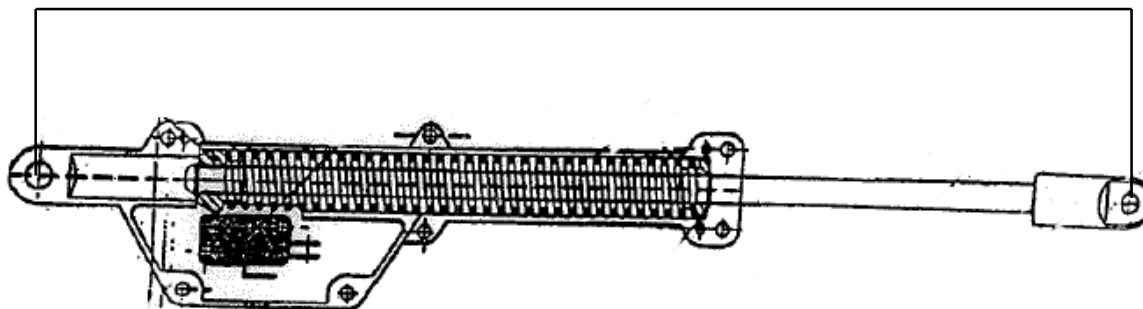

CLEAR OPENING	OVERALL ENTRANCE	DRIVE ARM LENGTH
500 mm	550 mm	265 mm
550 mm	600 mm	285 mm
600 mm	650 mm	310 mm
650 mm	700 mm	335 mm
700 mm	750 mm	360 mm
750 mm	800 mm	385 mm
800 mm	850 mm	410 mm
850 mm	900 mm	435 mm
900 mm	950 mm	460 mm
950 mm	1000 mm	485 mm
1000 mm	1050 mm	510 mm
1050 mm	1100 mm	535 mm
1100 mm	1150 mm	560 mm
1150 mm	1200 mm	585 mm

*Hand of Doors - as doors open as viewed from the landing.
Your Trade Discount has already been deducted. Prices exclude VAT.*

CAR: RAC 250 OPERATOR

The following items are parts from the Fermator RAC 250 Operator.

Please Note: These are currently special order from the Fermator Factory.

Please contact the Sales Team for part numbers, prices & availability.



Idle Pulley Tensioner & Support
For RAC 250 Operator (front view)

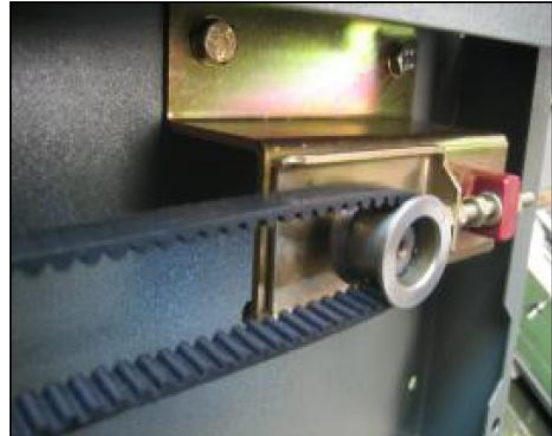

Idle Pulley Tensioner & Support For
RAC 250 Operator (left hand side view)

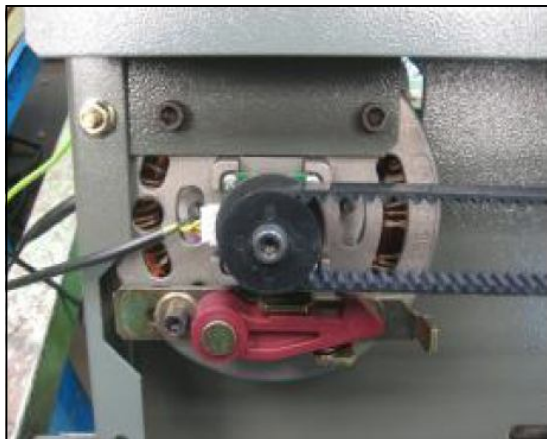

Stopping Retainer Assembly
For RAC 250 Operator



Stopping Retainer Trigger
For RAC 250 Operator

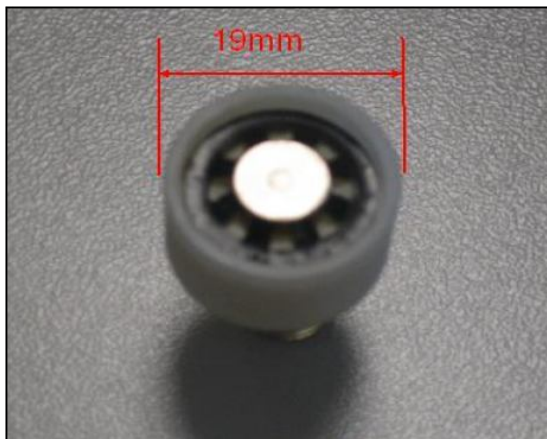

19mm Eccentric Roller
For RAC 250 Operator



48mm Concentric Roller
For RAC 250 Operator

Hand of Doors - as doors open as viewed from the landing.

CAR: RAC 250 OPERATOR

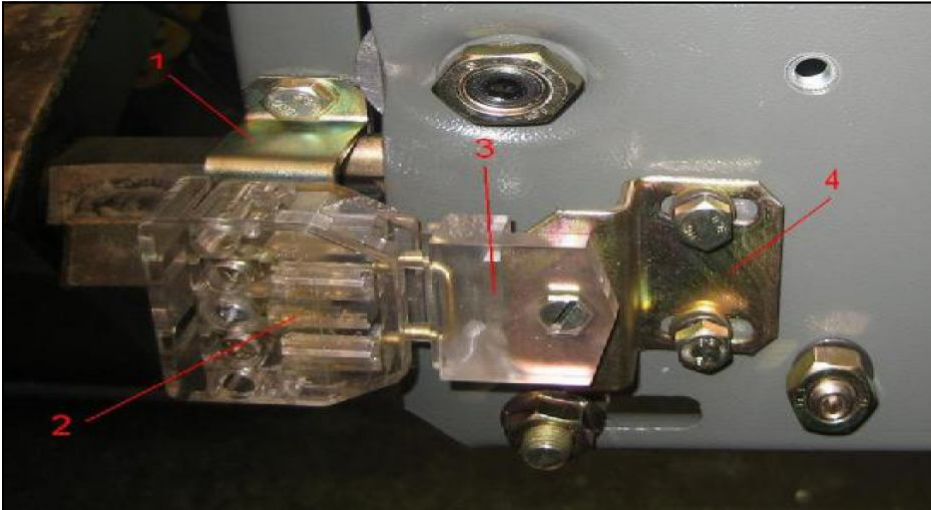

Electrical Contact Assembly For RAC 250 Operator

- 1. Contact Support
- 2. Electrical Contact Contact Bridge
- 3. Contact Bridge
- 4. Contact Bridge Support

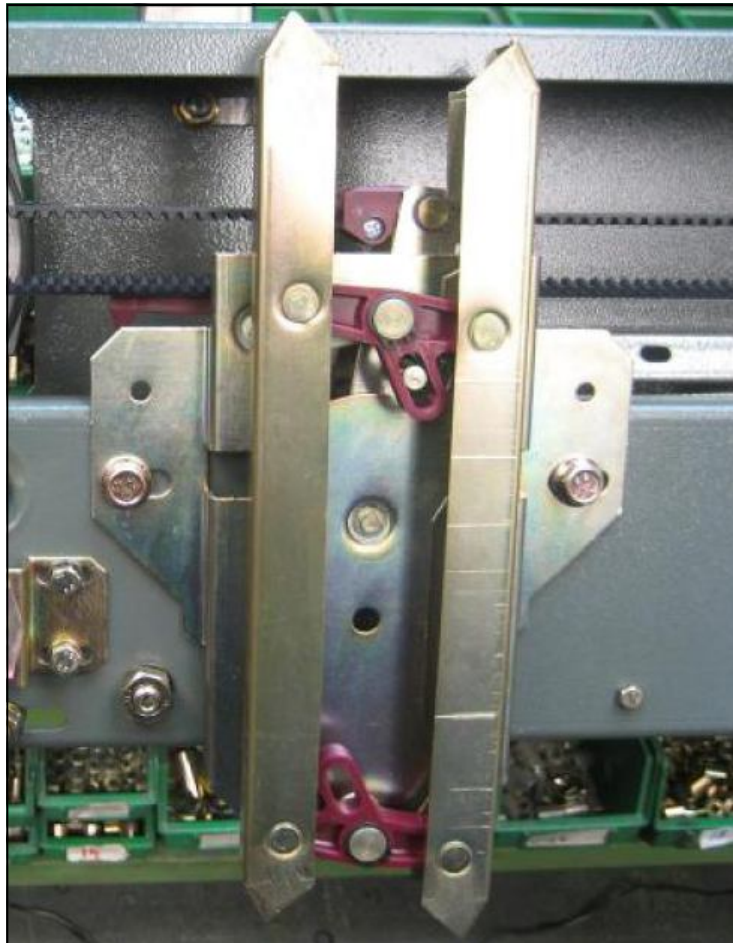

Skate For RAC 250 Operator

Other Items: VVVF Motor & VVVF Control Box are the same parts as used on a standard VVVF Operator (motor is supplied without the red casing)

Hanger Plates are special items and clear opening will need to be advised.

TOP TRACKS

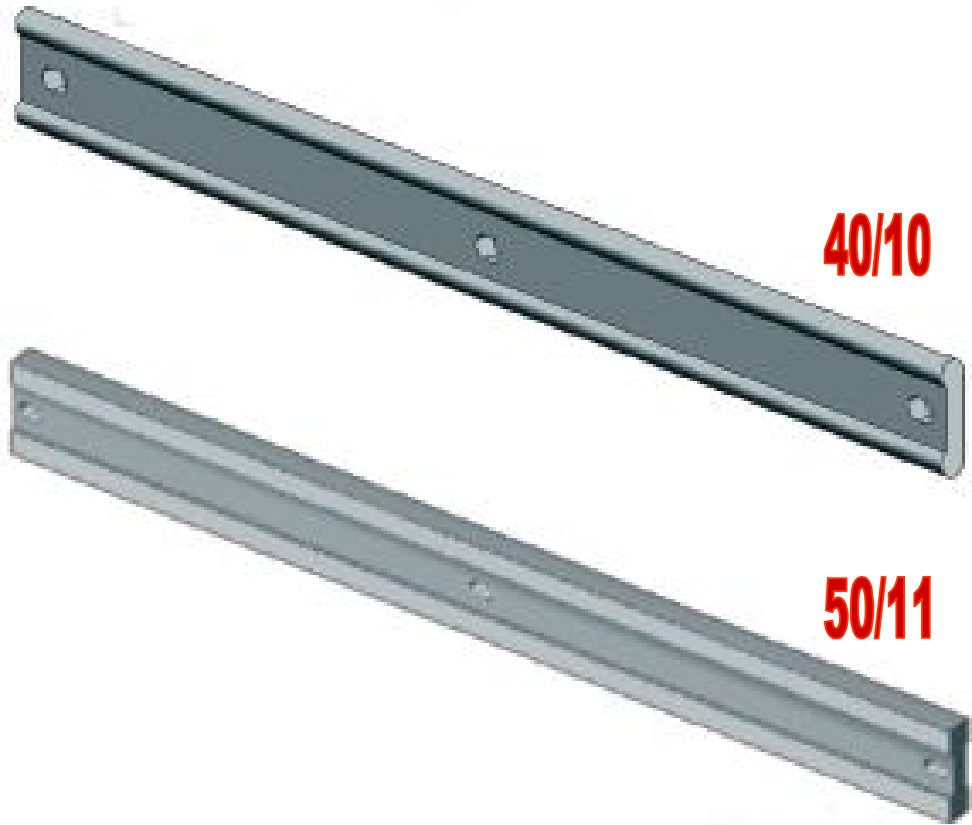











LOCKS / LOCK BEAKS



40/10 MECHANISM (2 panel centre)



TYPE	PART NO	DETAILS		IMAGE
CAR VVVF	90.26.00	Hanger Roller Concentric 56mm		
CAR VVVF	90.27.00	Kicking Roller Eccentric 54mm		
CAR Mechanical	10.70.20	Hanger Roller Concentric 48mm		
CAR Mechanical	10.70.10	Kicking Roller Eccentric 48mm		
CAR Mechanical	10.70.22	Kicking Roller Eccentric 48mm (3 panel side)		
LANDING 40/10	10.70.20	Hanger Roller Concentric 48mm		
LANDING 40/10	10.70.23	Kicking Roller Eccentric 30mm		
LANDING 50/11	90.26.00	Hanger Roller Concentric 56mm		
LANDING 50/11	90.27.00	Kicking Roller Eccentric 54mm		
LANDING 40/10	20.81.02	2 Lock Rollers Mounted on Lock Plate <i>Advise Hand</i>		
LANDING 50/11	20.81.02	2 Lock Rollers Mounted on Lock Plate <i>Advise Hand</i>		

*Hand of Doors - as doors open as viewed from the landing.
Your Trade Discount has already been deducted. Prices exclude VAT.*

Landing: brackets

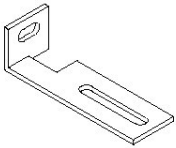
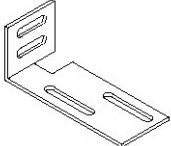
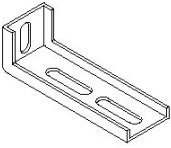
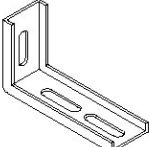
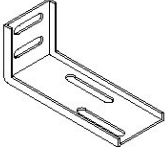
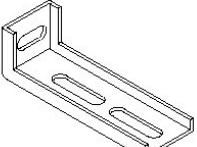
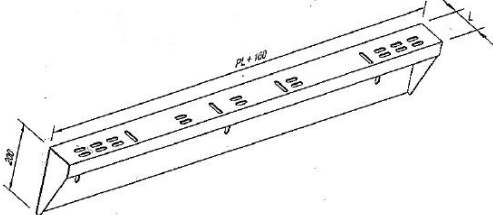
PART NO	ITEM		IMAGE
20.90.01	MODEL A MOUNTING BRACKET FOR LANDING DOORS <i>(HEAVY DUTY)</i>		
20.90.03	MODEL D MOUNTING BRACKET FOR LANDING DOORS <i>(HEAVY DUTY)</i>		
20.90.04	MODEL E MOUNTING BRACKET FOR LANDING DOORS <i>ALTERNATIVE FOR 20.90.07</i>		
20.90.05	MODEL F MOUNTING BRACKET FOR LANDING DOORS <i>(HEAVY DUTY)</i>		
20.90.06	MODEL G MOUNTING BRACKET FOR LANDING DOORS <i>(HEAVY DUTY)</i>		
20.90.07	MODEL H MOUNTING BRACKET FOR LANDING DOORS <i>STANDARD MODEL</i>		
<p>FULL WIDTH LANDING SILL SUPPORTS AVAILABLE</p> <p>Width = clear opening + 160mm Height = 200mm Depth (L) = 50, 80, 130 or 190mm</p> <p>Price on application Special order</p>			

*Hand of Doors - as doors open as viewed from the landing.
Your Trade Discount has already been deducted. Prices exclude VAT.*

Landing: Bottom tracks



Standard Aluminium & Gold Anodised

Total Weight: **1200 kg**

Load on Support Point: **300 kg**



Reinforced Aluminium

Total Weight: **4800 kg**

Load on Support Point: **1200 kg**



Steel Section

Total Weight: **3600 kg**

Load on Support Point: **900 kg**

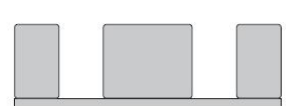

Solid Steel

Total Weight: **> 4800 kg**

Load on Support Point: **> 1200 kg**

The loads stated above are the maximum loads the tracks can support.
 Prices are same for all configurations of tracks (i.e. single panel, 2 panel etc) **Contact Sales for other sizes.**

Type	Car	Landing	Slimline Car With Auto Landing	Slimline Car With Hinged Landing
Single Panel	54mm	54mm	n/a	n/a
2 Panel Centre	54mm	54mm	n/a	n/a
2 Panel Side	90mm	90mm	70mm	70mm
3 Panel Side	135mm	135mm	90mm	90mm & 70mm
4 Panel Centre	90mm	90mm	70mm	70mm & 80mm (700mm Clear opening only)
4 Panel Side	180mm	180mm	n/a	n/a
6 Panel Centre	135mm	135mm	90mm	n/a
8 Panel Centre	180mm	180mm	n/a	n/a

Clear Opening	Standard Aluminium	Reinforced Aluminium	Gold Anodised	Steel Section	Solid Steel	Stainless Steel Section	Solid Stainless Steel
500 mm							
600 mm							
700 mm							
800 mm							
900 mm							
1000 mm							
1100 mm							
1200 mm							
1300 mm							
1400 mm							
1500 mm							
1600 mm							
1700 mm							
1800 mm							
1900 mm							
2000 mm							
2100 mm							
2200 mm							



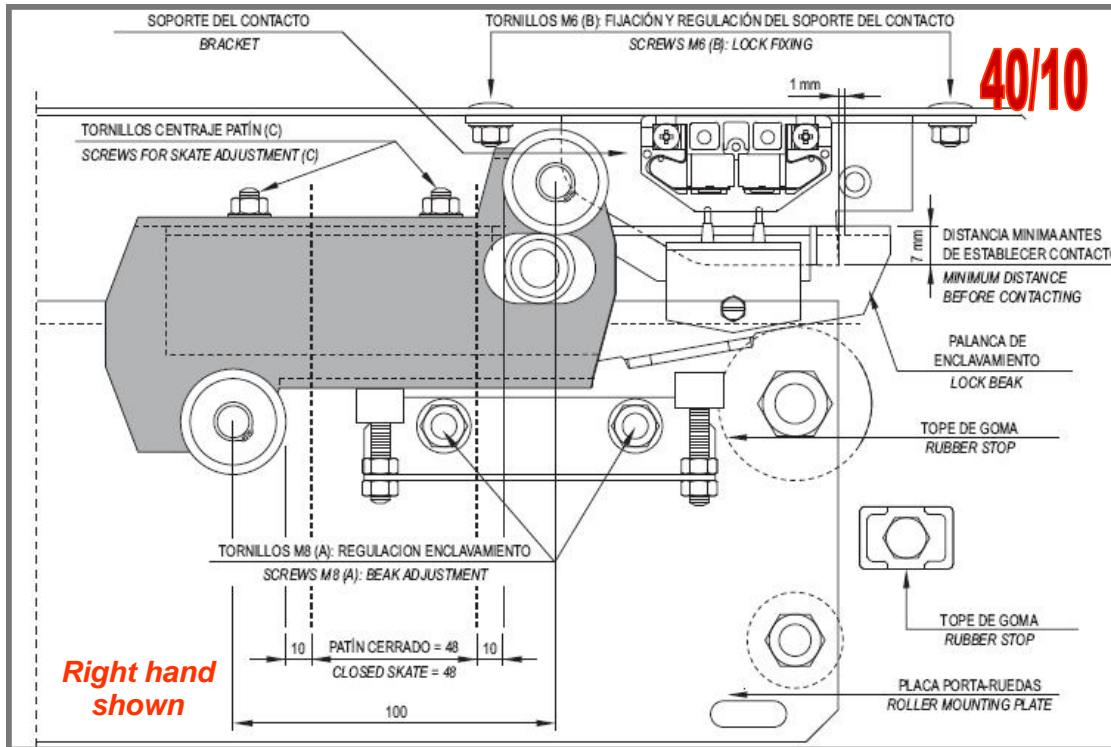

Your Trade Discount has already been deducted. Prices exclude VAT.



ALL MAKE UP A COMPLETE 40/10 LANDING LOCK & ACCESSORIES

PART NO	ITEM	Qty Req'd	
20.10.07	M6 RUBBER STOPPER	2	
20.20.02	MAIN PART LOCK SUPPORT (image not shown) <i>Indicate type, hand & clear opening SEE PAGE 43</i>	1	
20.20.03	LOCK SWITCH SUPPORT & SWITCH & ROD <i>Indicate type, hand & clear opening</i>	1	
20.20.04	LOCK SERIES SWITCH	1	
20.30.03	COMPLETE DOOR RELEASE SYSTEM WITH SPRING (image not shown) <i>Indicate type & hand</i>	1	
20.30.05	DOOR RELEASE KEY (image not shown)	1	
20.80.01	LANDING LOCK BEAK <i>Indicate type & hand</i>	1	
20.81.02	LOCK PLATE WITH 2 ROLLERS <i>Indicate type & hand</i>	1	
	OR		
20.81.03	LOCK PLATE WITH 2 ROLLERS for 4pcp, with clear opening less than 915mm <i>Indicate type & hand</i>		

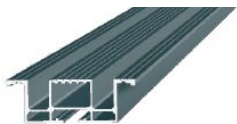
*Hand of Doors - as doors open as viewed from the landing.
Your Trade Discount has already been deducted. Prices exclude VAT.*

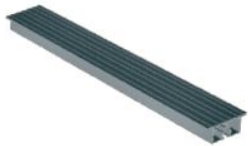
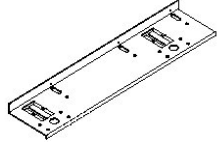
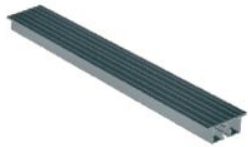
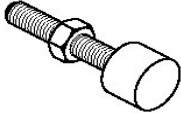
PART NO	ITEM		IMAGE
90.19.00	SET OF 2 BOTTOM GUIDE SHOES		
10.70.20	HANGER ROLLER WITH CONCENTRIC SHAFT 48mm Ø		
10.70.23	KICKING ROLLER WITH ECCENTRIC SHAFT 30mm Ø		
10.80.01	ALUMINIUM BOTTOM TRACK/ SILL <i>Indicate type & clear opening</i> <i>Please refer to page 40</i>		
10.80.02	LANDING TOE GUARD <i>Indicate clear opening</i>		
10.80.03	TRACK/SILL INFILL 60mm WIDTH SIDE OPENING DOORS <i>Indicate clear opening</i>		
10.80.04	SILL SUPPORT <i>Indicate type, hand & clear opening</i>		
10.80.08	TRACK/SILL INFILL 70mm WIDTH FOR CENTRE PARTING DOORS <i>Indicate clear opening</i>		
20.10.07	RUBBER STOP M6		



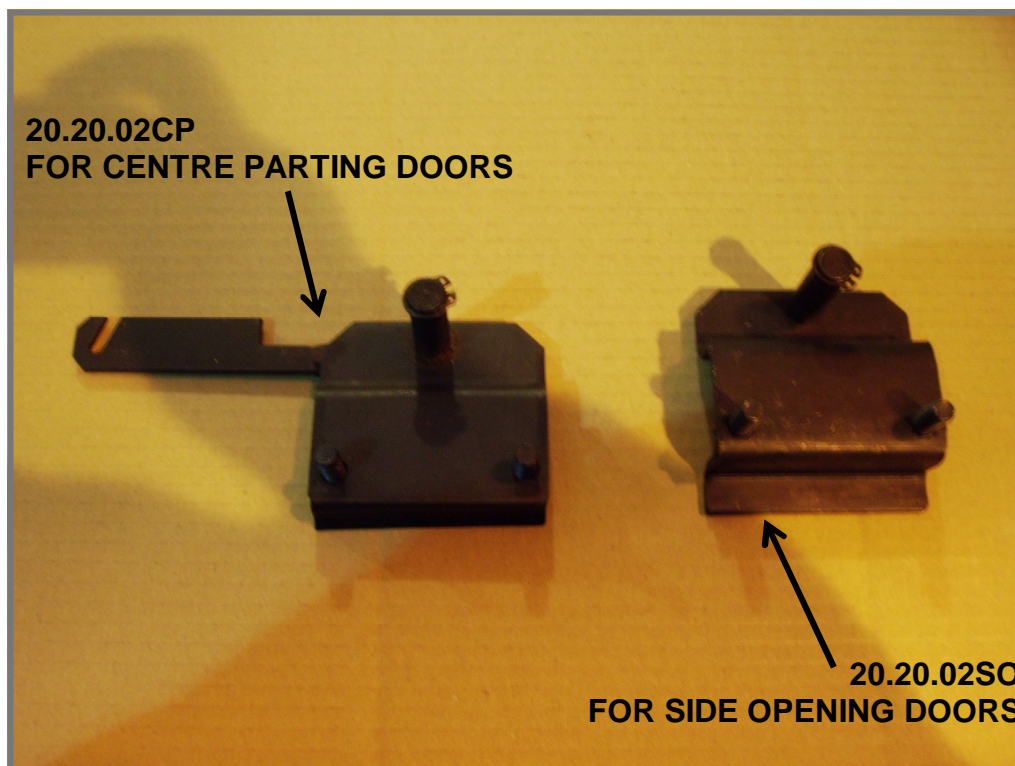

*Hand of Doors - as doors open as viewed from the landing.
Your Trade Discount has already been deducted. Prices exclude VAT.*

PART NO	ITEM
20.20.02	<p>SUPPORT FOR MAIN PART LOCK</p> <p><i>Indicate type/hand & clear opening</i></p> <p>2 models available:</p> <p>Centre Parting - this has a hooked arm for the closer spring which eliminates the use of Part number 20.70.04 (Spring Fixing)</p> <p>Side Opening - No hooked arm</p> <p>Refer to Photo below</p>



*Hand of Doors - as doors open as viewed from the landing.
Your Trade Discount has already been deducted. Prices exclude VAT.*





Landing: model 40/10

PART NO	ITEM		IMAGE
20.20.03	LOCK SWITCH SUPPORT WITH SWITCH & ROD <i>Indicate type, hand & clear Opening (Left hand shown)</i>		
20.20.04	LOCK SERIES SWITCH <i>Please refer to page 46</i>		
20.30.01	DOOR RELEASE ROD NO LONGER AVAILABLE AS A SPARE, PLEASE SEE PART NO 20.20.03 ABOVE		
20.30.03	COMPLETE DOOR RELEASE SYSTEM SPRING INCLUDE <i>Indicate type & hand</i> <i>Makes up lock release in header</i>		
20.30.05	PLASTIC TRIANGULAR EMERGENCY KEY		

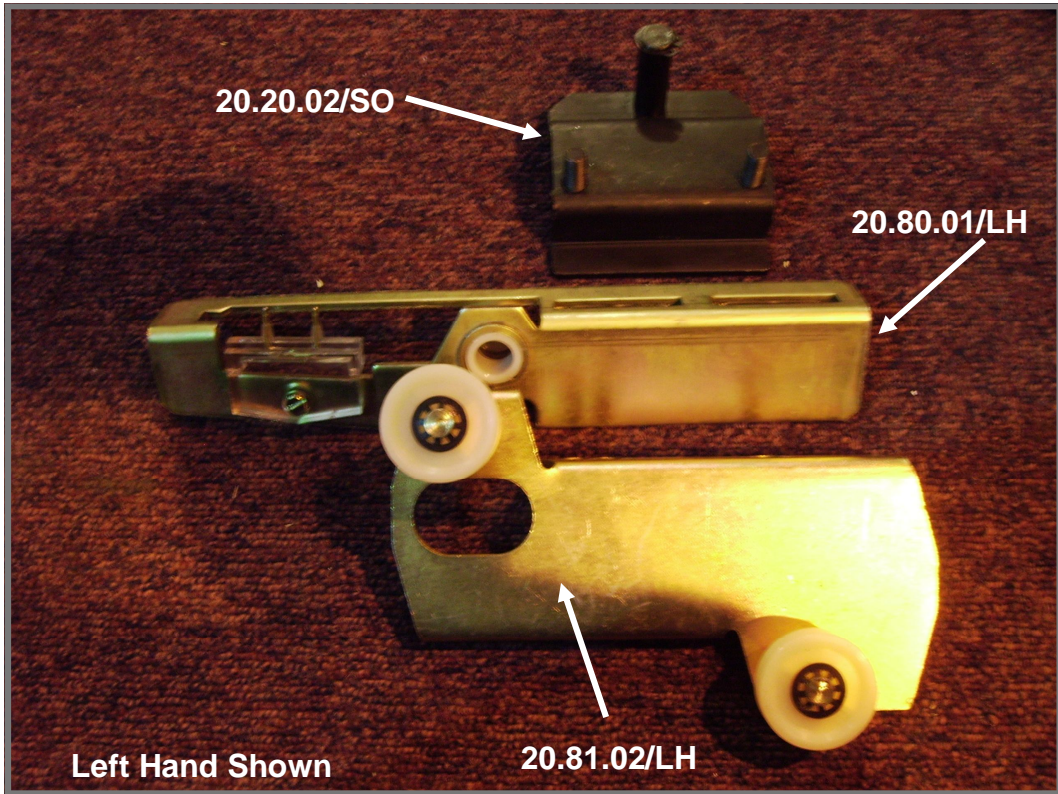
*Hand of Doors - as doors open as viewed from the landing.
 Your Trade Discount has already been deducted. Prices exclude VAT.*

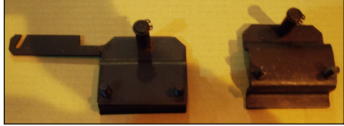
Landing: modelL 40/10



ALL MAKE UP THE 'MOVING' PART OF A LANDING LOCK - TYPE 40/10			
PART NO	ITEM		IMAGE
20.20.02	SUPPORT FOR MAIN PART LOCK <i>Indicate type, hand & clear opening</i> <i>Please refer to page 43</i>		 <p style="text-align: center;"><i>Centre Parting</i> <i>Side Opening</i></p>
20.80.01	LANDING LOCK BEAK <i>Indicate type & hand</i> Right hand shown		
20.81.02	LOCK PLATE WITH 2 ROLLERS <i>Indicate type & hand</i>		
20.81.03	OR LOCK PLATE WITH 2 ROLLERS for 4pcp, with clear opening less than 915mm <i>Indicate type & hand</i>		
20.20.04	LOCK SERIES SWITCH		

*Hand of Doors - as doors open as viewed from the landing.
Your Trade Discount has already been deducted. Prices exclude VAT.*

Landing: model 40/10

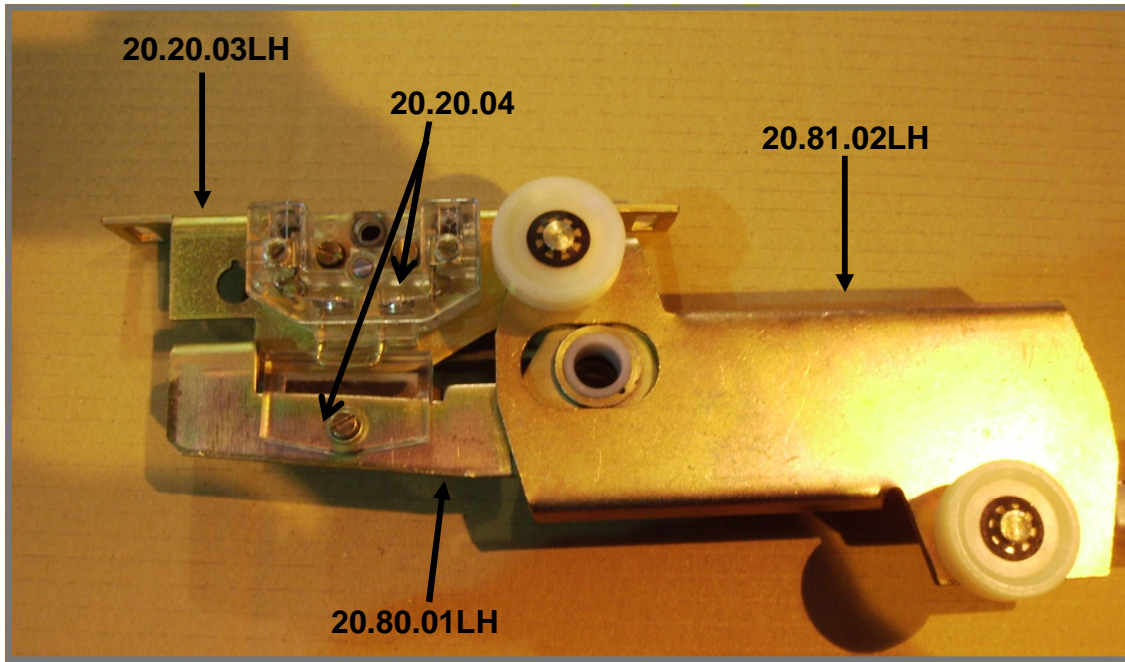

ALL MAKE UP THE 'FIXED' PART OF A LANDING LOCK TYPE 40/10

PART NO	ITEM		IMAGE
20.20.04	LOCK SERIES SWITCH		
20.30.03	COMPLETE DOOR RELEASE SYSTEM & SPRING <i>Indicate type & hand</i>		

PART No	ITEM	IMAGE	
20.51.02 Sold in sets of 2	DOOR PANEL HANGER BOLT (specify if car or landing) <i>4 models are available with long & short threaded bolt</i> Car Old Model - Long Car New Model - Long Landing Old Model - Short Landing New Model - Short <i>2 Per door panel required</i>		
		OLD MODEL	NEW MODEL

*Hand of Doors - as doors open as viewed from the landing.
Your Trade Discount has already been deducted. Prices exclude VAT.*

PART NO	ITEM		IMAGE
20.51.03	PLAQUE FOR VULKALLAN GUIDE SPECIAL ORDER <i>Indicate type, hand & clear opening</i>		
20.60.01	AIR CORD PULLEY MOUNT SPECIAL ORDER <i>Indicate type, hand & clear opening</i>		
20.70.02	CLOSING SPRING <i>Indicate clear opening</i> Up to 1100mm clear opening: 374mm long x 16mm diameter spring Over 1100mm clear opening: 474mm long x 16mm diameter spring Old Model: over 1100mm clear opening 526mm spring x 26mm diameter		
20.70.03	DOOR SPRING CLOSER PULLEY 42mm, 50mm or 60mm Ø		
20.70.04	DOOR CLOSER SPRING FIXING <i>Used to secure 20.70.02 on side opening mechanisms. Not used on centre parting.</i>		
20.80.01	LANDING LOCK BEAK <i>Indicate type & hand</i> <i>Right hand shown</i>		
20.81.02	LOCK PLATE WITH 2 ROLLERS <i>Indicate type & hand</i>		
20.81.03	<i>OR</i> LOCK PLATE WITH 2 ROLLERS for 4pcp, with clear opening less than 915mm <i>Indicate type & hand</i>		

*Hand of Doors - as doors open as viewed from the landing.
Your Trade Discount has already been deducted. Prices exclude VAT.*

*AIRCORD LENGTHS - All sizes are in mm.**Prices available on request.***PCP = CENTRE PARTING DOORS****PSO = SIDE OPENING DOORS****PART CODE: 90.23.00/Length Required**

Clear Opening	2PCP	4PCP (1)	4PCP (2)	6PCP	8PCP	2PSO	3PSO	4PSO
600	2370	1930	660	-	-	1080	760	660
650	2570	2080	710	-	-	1180	910	710
700	2770	2280	710	-	-	1180	960	710
750	2970	2430	760	-	-	1280	1010	760
800	3170	2580	760	-	-	1280	1010	760
850	3370	2730	810	-	-	1380	1080	810
900	3570	2880	810	-	-	1380	1080	810
950	3770	3030	960	-	-	1480	1180	960
1000	3970	3180	960	-	-	1480	1180	960
1100	4370	3480	1010	-	-	1580	1280	1010
1200	4770	-	1080	760	-	1680	1280	1080
1300	5170	-	1180	910	-	1780	1380	1180
1400	5570	-	1180	960	710	1880	1480	1180
1500	5970	-	1280	1010	760	1980	1480	1280
1600	6370	-	1280	1010	760	2080	1580	1280
1700	-	-	1380	1080	810	2180	1580	1380
1800	-	-	1380	1080	810	2280	1680	1380
1900	-	-	1480	1180	960	2380	1680	1480
2000	-	-	1480	1180	960	2480	1780	1480
2100	-	-	1580	1280	1010	-	-	-
2200	-	-	1580	1280	1010	-	-	-
2300	-	-	1680	1280	1080	-	-	-
2400	-	-	1680	1280	1080	-	-	-
2500	-	-	1780	1380	1180	-	-	-
2600	-	-	1780	1380	1180	-	-	-
2700	-	-	1880	1480	1180	-	-	-
2800	-	-	1880	1480	1180	-	-	-
2900	-	-	1980	1580	1280	-	-	-
3000	-	-	1980	1580	1280	-	-	-

(1): Aircord Length Across Entrance**(2): Aircord Length Across Door Panel**

*Hand of Doors - as doors open as viewed from the landing.
Your Trade Discount has already been deducted. Prices exclude VAT.*

50/11

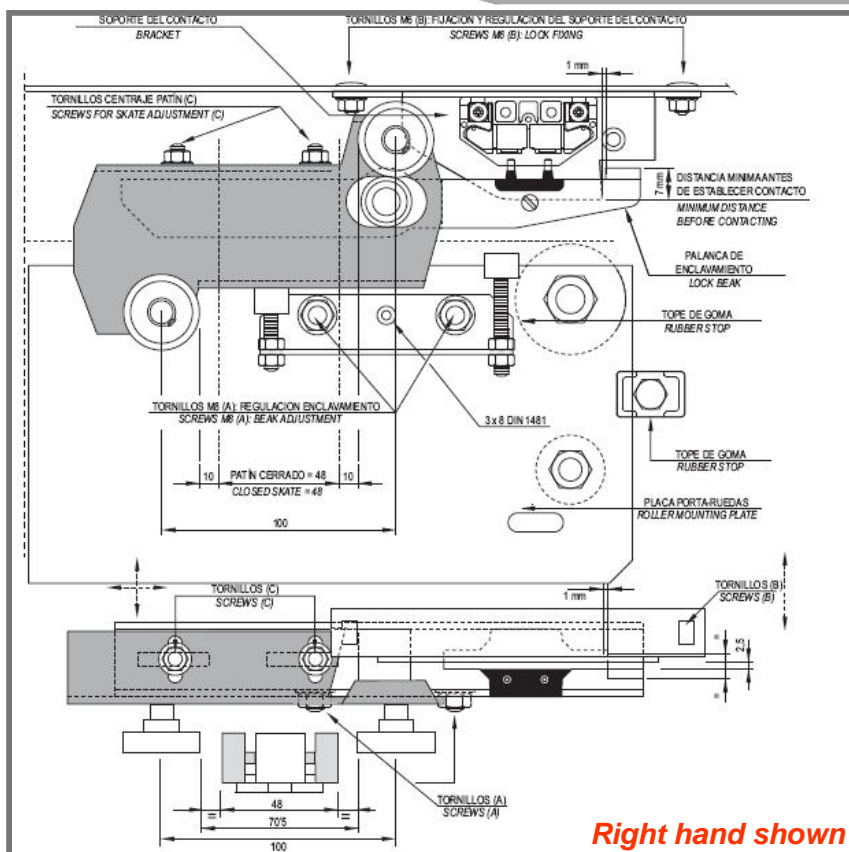

ALL MAKE UP A COMPLETE 50/11 LANDING LOCK & ACCESSORIES

PART NO	ITEM	QtY	
20.10.07	M6 RUBBER STOPPER	2	
91.03.03	MAIN PART LOCK SUPPORT WITH ROD (image not shown) <i>advise if centre or side opening</i>	1	
20.20.04	LOCK SERIES SWITCH	1	
20.30.03	COMPLETE DOOR RELEASE SYSTEM & SPRING (image not shown) <i>Indicate type & hand</i>	1	
20.30.05	DOOR RELEASE KEY (image not shown)	1	
91.03.01	LANDING LOCK BEAK <i>Indicate type & hand</i>	1	
20.81.02	LOCK PLATE WITH 2 ROLLERS <i>Indicate type & hand</i>	1	
91.03.02	ELECTRICAL CONTACT	1	
91.03.04	SECURITY RETAINER (image not shown)	1	
92.03.05	RUBBER STOP SUPPORT	1	
91.03.06	LOCK BEAK 2mm SUPPLEMENT	1	



*Hand of Doors - as doors open as viewed from the landing.
Your Trade Discount has already been deducted. Prices exclude VAT.*

Landing: model 50/11

PART NO	ITEM		IMAGE
20.10.07	M6 RUBBER BUFFER		
20.20.04	LOCK SERIES SWITCH		
20.30.03	COMPLETE DOOR RELEASE SYSTEM WITH SPRING		
20.30.05	PLASTIC TRIANGULAR EMERGENCY KEY		
20.81.02	LOCK PLATE WITH 2 ROLLERS <i>Indicate type & hand</i>		
20.81.03	<i>OR</i> LOCK PLATE WITH 2 ROLLERS for 4pcp, with clear opening less than 915mm <i>Indicate type & hand</i>		
90.23.00	AIR CORD - CAR <i>Please refer to air cord table on page 52 for sizes</i>		
90.26.00	CONCENTRIC HANGER ROLLER 56mm Ø <i>Same part number for VF Car Hanger Rollers</i>		
90.27.00	ECCENTRIC KICKING ROLLER 54MM Ø <i>Same part number for VF Car Kicking Rollers</i>		

*Hand of Doors - as doors open as viewed from the landing.
Your Trade Discount has already been deducted. Prices exclude VAT.*

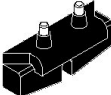
Landing: model 50/11

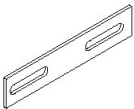
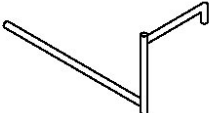
PART NO	ITEM		IMAGE
91.03.01	LANDING LOCK BEAK <i>Not handed, universal</i>		
91.03.02	ELECTRICAL CONTACT		
91.03.03	SUPPORT FOR THE MAIN PART LOCK <i>Advise centre or side opening</i>		 <p style="text-align: center;"><i>Centre Parting</i></p> <p style="text-align: center;"><i>Side Opening</i></p>
91.03.06	LANDING LOCK BEAK SUPPLEMENT 2mm THICK		
91.03.07	DOOR RELEASE ROD <i>NO LONGER AVAILABLE AS A SPARE, PLEASE SEE PART NO 91.03.03 ABOVE</i>		

*Hand of Doors - as doors open as viewed from the landing.
 Your Trade Discount has already been deducted. Prices exclude VAT.*

AIRCORD LENGTHS - All sizes are in mm.**Prices available on request.****PCP = CENTRE PARTING DOORS****PSO = SIDE OPENING DOORS****PART CODE: 90.23.00/Length Required**

Clear Opening	2PCP	4PCP (1)	4PCP (2)	6PCP	8PCP	2PSO	3PSO	4PSO
600	2480	-	-	-	-	1080	860	-
650	2680	2080	760	-	-	1180	860	760
700	2880	2280	760	-	-	1180	960	810
750	2980	2430	810	-	-	1280	960	810
800	3180	2580	810	-	-	1280	1010	860
850	3380	2730	860	-	-	1380	1010	860
900	3580	2880	910	-	-	1380	1080	910
950	3780	3030	960	-	-	1480	1080	910
1000	3980	3180	1010	-	-	1480	1180	960
1100	4380	3480	1080	810	-	1580	1280	1010
1200	4780	-	1080	810	-	1680	1280	1060
1300	5180	-	1180	860	-	1780	1380	1110
1400	5580	-	1180	960	760	1880	1480	1180
1500	5980	-	1280	1010	810	1980	1480	1280
1600	6380	-	1280	1010	810	2080	1580	1280
1700	-	-	1380	1080	860	2180	1680	1380
1800	-	-	1380	1080	910	2280	1680	1380
1900	-	-	1480	1140	960	2380	1780	1480
2000	-	-	1480	1180	960	2480	1880	1480
2100	-	-	1580	1180	1010	-	-	-
2200	-	-	1580	1280	1010	-	-	-
2300	-	-	1680	1280	1060	-	-	-
2400	-	-	1680	1280	1080	-	-	-
2500	-	-	1780	1380	1080	-	-	-
2600	-	-	1780	1380	1110	-	-	-
2700	-	-	1880	1480	1140	-	-	-
2800	-	-	1880	1480	1180	-	-	-
2900	-	-	1980	1480	1180	-	-	-
3000	-	-	1980	1580	1280	-	-	-

(1): Aircord Length Across Entrance**(2): Aircord Length Across Door Panel**

*Hand of Doors - as doors open as viewed from the landing.
Your Trade Discount has already been deducted. Prices exclude VAT.*

LANDING: mechANICAL cAMs



RETRACTABLE CAM

To suit VF Car & Hinged Landing

Universal not handed

Part no: 10.81.00



SIDE ACTING INVERTED CAM

To suit VF Car & Hinged Landing

Universal not handed

Part no: 10.82.00



FRONT ACTING RETRACTABLE CAM

To suit VF Car & Hinged Landing

Right Hand (Shown)
Part no: 10.83.00

Left Hand
Part no: 10.84.00

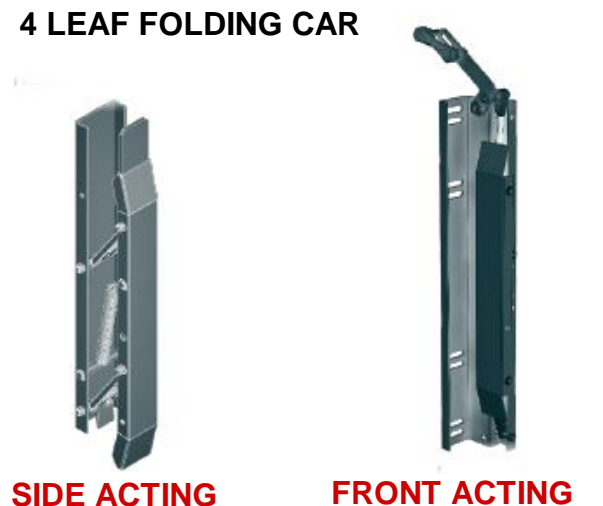

4 LEAF FOLDING CAR

SIDE ACTING

FRONT ACTING



SIDE ACTING RETRACTABLE CAM

To suit 4 Leaf Folding Car & Hinged Landing

Universal not handed

Part no: 50.80.00



FRONT ACTING RETRACTABLE CAM

To suit 4 Leaf Folding Car & Hinged Landing

Left Hand (Shown)
Part no: 50.80.01/LH

Right Hand
Part no: 50.80.01/RH

Left or Right Hand denotes which side door is hinged on. Cams fit on opposite side of Operator. Your Trade Discount has already been deducted. Prices exclude VAT.

Landing: hinged

PART NO	ITEM		IMAGE
10.81.00	RETRACTABLE CAM (Automatic VF Car) Not Handed <i>Please refer to page 53</i>		
10.82.00	SIDE ACTING INVERTED RETRACTABLE CAM (Automatic VF Car) Not Handed <i>Please refer to page 53</i>		
10.83.00	FRONT ACTING RIGHT HAND RETRACTABLE CAM (Automatic VF Car) <i>Please refer to page 53</i>		
10.84.00	FRONT ACTING LEFT HAND RETRACTABLE CAM (Automatic VF Car) <i>Please refer to page 53</i>		
80.12.01	HINGE		
80.12.02	HINGE PIN SCREW		
80.12.03	PIN MOUNTING PLATE		
80.13.00	COMPLETE DOOR CLOSER MECHANISM <i>Indicate Hand</i>		





HANDING OF HINGED DOORS ARE VIEWED FROM THE LANDING

LEFT HAND OR RIGHT HAND OPENING DENOTES WHICH SIDE THE HINGES ARE ON

IF A LOCK IS ON THE RIGHT HAND SIDE THEN IT IS A LEFT HAND OPENING (hinged left)

IF A LOCK IS ON THE LEFT HAND SIDE THEN IT IS A RIGHT HAND OPENING (hinged right)

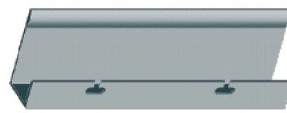
Your Trade Discount has already been deducted. Prices exclude VAT.

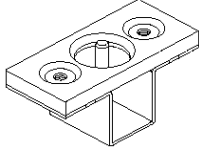
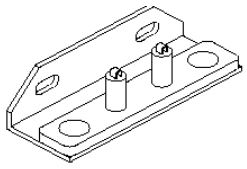
PART NO	ITEM		IMAGE
80.14.01	VISION PANEL FRAME IN ALUMINIUM PROFILE Special Order <i>(FERMATOR MODEL)</i>		
80.14.02	VISION PANEL GLASS Special Order <i>(FERMATOR MODEL)</i>		
80.14.03	VISION PANEL FIXING CLIP - SET OF 8 <i>(FERMATOR MODEL)</i>		
80.15.01	HANDLE		
80.15.02	PUSH PLATE		
80.16.02	ALJO LOCK FEMALE		
80.16.03	ALJO CONTACT COMPLETE		





HANDING OF HINGED DOORS ARE VIEWED FROM THE LANDING

LEFT HAND OR RIGHT HAND OPENING DENOTES WHICH SIDE THE HINGES ARE ON

IF A LOCK IS ON THE RIGHT HAND SIDE THEN IT IS A LEFT HAND OPENING (hinge left)

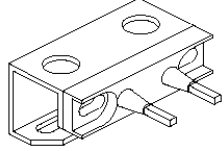
IF A LOCK IS ON THE LEFT HAND SIDE THEN IT IS A RIGHT HAND OPENING (hinge right)

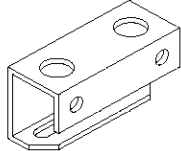
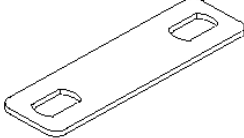
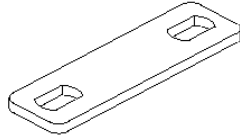
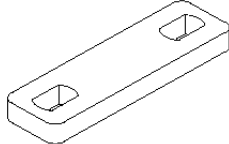
Your Trade Discount has already been deducted. Prices exclude VAT.

PART NO	ITEM		IMAGE
80.17.02	KRONENBURG LOCK FEMALE		
80.18.00	KRONENBURG CONTACT COMPLETE		
80.18.01	KRONENBURG CONTACT MALE		
80.18.02	KRONENBURG CONTACT PLUG SUPPORT		
80.18.03	CONTACT SUPPLEMENT 1mm THICK		
80.18.04	CONTACT SUPPLEMENT 2mm THICK		
80.18.05	CONTACT SUPPLEMENT 4mm THICK		
80.19.01	RUBBER STOP		

HANDING OF HINGED DOORS ARE VIEWED FROM THE LANDING





LEFT HAND OR RIGHT HAND OPENING DENOTES WHICH SIDE THE HINGES ARE ON

IF A LOCK IS ON THE RIGHT HAND SIDE THEN IT IS A LEFT HAND OPENING (hinge left)

IF A LOCK IS ON THE LEFT HAND SIDE THEN IT IS A RIGHT HAND OPENING (hinge right)

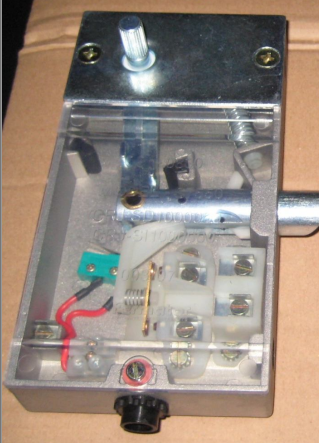
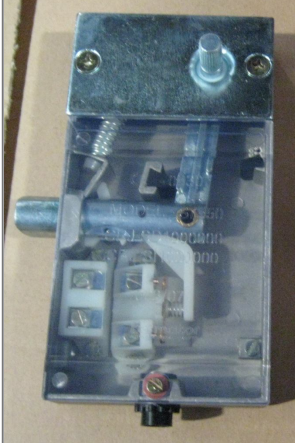
Your Trade Discount has already been deducted. Prices exclude VAT.

LANDING: hINGeD Locks

	<p>FERMATOR LOCK 80.16.01/SLH SIDE ACTING Left Hand Hinged As viewed from landing</p>		<p>FERMATOR LOCK 80.16.01/SRH SIDE ACTING Right Hand Hinged As viewed from landing</p>
	<p>GERVALL LOCK 80.21.00 SIDE ACTING Left Hand Hinged As viewed from landing</p>		<p>GERVALL LOCK 80.21.01 SIDE ACTING Right Hand Hinged As viewed from landing</p>
	<p>GERVALL LOCK 80.21.02 FRONT TO BACK Left Hand Hinged As viewed from landing</p>		<p>GERVALL LOCK 80.21.03 FRONT TO BACK Right Hand Hinged As viewed from landing</p>

FERMATOR & GERVALL ARE A REPLACEMENT FOR ALJO LOCKS.

(some modification by the Lift Company will be required ie: new holes for mounting the lock and also a new hole for the activation pin).

Handing of Hinged Doors are viewed from the Landing.

LEFT HAND OR RIGHT HAND OPENING DENOTES WHICH SIDE THE HINGES ARE ON.

- **IF A LOCK IS ON THE RIGHT HAND SIDE THEN IT IS A LEFT HAND OPENING (hinge left)**
- **IF A LOCK IS ON THE LEFT HAND SIDE THEN IT IS A RIGHT HAND OPENING (hinge right)**

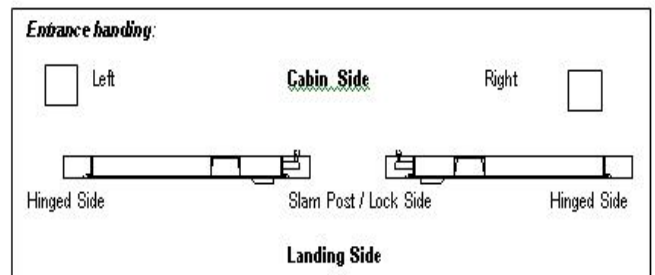

Your Trade Discount has already been deducted. Prices exclude VAT.

Landing: hinged

PART NO	ITEM		IMAGE
80.16.01/SLH	FERMATOR LOCK SIDE ACTING Hinged on Left Hand Side <i>See page 57</i>		
80.16.01/SRH	FERMATOR LOCK SIDE ACTING Hinged on Right Hand Side <i>See page 57</i>		
80.17.01	KRONENBURG LOCK <i>Indicate hand Side Acting or Front to Back NB: special order</i>		
80.20.00	PRUDHOMME MECHANICAL LOCK <i>Indicate hand Side Acting or Front to Back NB: special order</i>		
80.21.00	GERVALL LOCK SIDE ACTING Hinged on Left Hand Side <i>See page 57</i>		
80.21.01	GERVALL LOCK SIDE ACTING Hinged on Right Hand Side <i>See page 57</i>		
80.21.02	GERVALL LOCK FRONT TO BACK ACTING Hinged on Left Hand Side <i>See page 57</i>		
80.21.03	GERVALL LOCK FRONT TO BACK ACTING Hinged on Right Hand Side <i>See page 57</i>		

For further details please see page 57

HANDING OF HINGED DOORS ARE VIEWED FROM THE LANDING
LEFT HAND OR RIGHT HAND OPENING DENOTES WHICH SIDE THE HINGES ARE ON
IF A LOCK IS ON THE RIGHT HAND SIDE THEN IT IS A LEFT HAND OPENING (hinge left)
IF A LOCK IS ON THE LEFT HAND SIDE THEN IT IS A RIGHT HAND OPENING (hinge right)

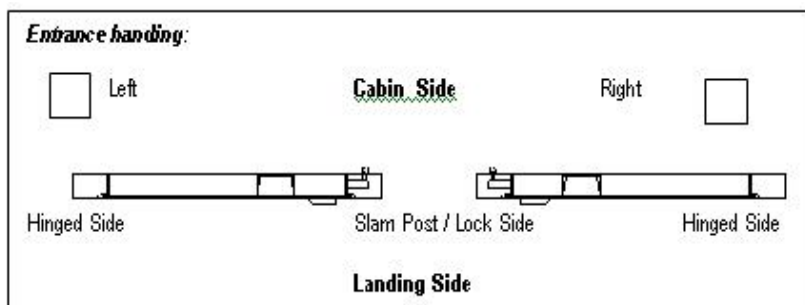

VF PROGRAMMING TOOL

For use on VF Fermator Door Operators
Fault diagnostic tool. Custom modification of internal
program parameters and performance characteristics.

Recommended for 2 motor & modernisation operators.

Part No: 90.34.00

**MODERNISATION DOOR ASSEMBLY TOOL**

Template Tool helps to align/plumb Fermator
Modernisation landing doors without frames.

Tube size: 30 x 25 x 1 mm
(based on clear opening of 800 x 2000 mm)

Part No: FERM/TUBE

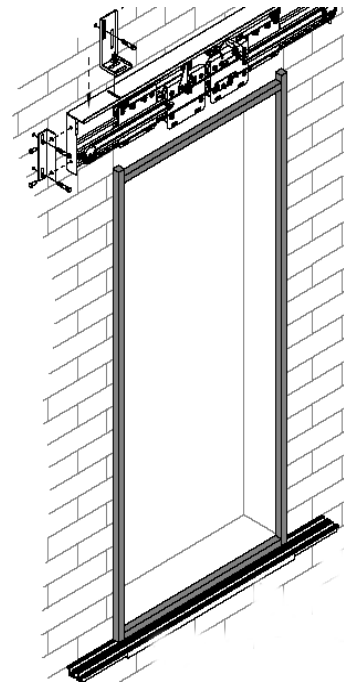

*Hand of Doors - as doors open as viewed from the landing.
Your Trade Discount has already been deducted. Prices exclude VAT.*

RAPID ORDER FORM

Company/Branch:	Contact:	Order no:
Site reference:	Contact tel no:	Delivery address:
Delivery time required:	Additional Comments:	

Please photocopy and complete details below and fax to 01352 735733

DESCRIPTION Include hand, type etc where applicable	PART NUMBER	Price each	Quantity required

Free Of Charge Delivery for all orders under 15kg - Next day Delivery by 5.30pm, UK mainland only.

2.30pm daily cut off for next day delivery.

Your Trade Discount has already been deducted from all prices in this catalogue.

Minimum Order Charge of £40 applies. Items are sold in accordance with GLE standard terms & conditions. Prices exclude delivery & VAT.

NOTES PAGE FOR YOUR USE



- ▶ Autodiallers
- ▶ Buffers
- ▶ Car Top Controls
- ▶ Controllers
- ▶ DDA Solutions (EN81-70)
- ▶ Divertors
- ▶ Door Detectors & Sensors
- ▶ Doors & Spares - Anti Vandal (EN81-71)
- ▶ Doors & Spares - Folding
- ▶ Doors & Spares - Hinged
- ▶ Doors & Spares - VVVF/Sliding/Slim
- ▶ Doors - Local Authority/Heavy Duty Robusta
- ▶ Doors - Glass
- ▶ Doors - Modernisation Solutions
- ▶ Goods Lifts
- ▶ Governors & Tension Weights
- ▶ Guiderail & Accessories
- ▶ Guide Shoes & Accessories
- ▶ Indicators - TFT, Dot Matrix & 7 Segment
- ▶ Lift Cars & Slings
- ▶ Lifts - MRL Optima Gearless
- ▶ Lifts - Conventional Traction & Hydraulic
- ▶ Lifts - Bespoke Lifts
- ▶ Lifts - Scenic Lifts
- ▶ Load Weighing Units
- ▶ Machines
- ▶ Pit Items
- ▶ Pushbuttons, Plates & Fixtures
- ▶ Safety Gears
- ▶ Safety Items
- ▶ Seats
- ▶ Speech Units

GLE reserves the right to modify any product details/specification contained within this publication without prior notice.

